

**TECHNICAL DOCUMENTS**

**FOR**

**COURRIER ARRIVÉ LE**

**- 3 JAN. 1997**

**82.**

**PRESIDENT**  
**ELECTRONICS**

**PRESIDENT RANDY**

**FOR**

**AFTER SERVICE**

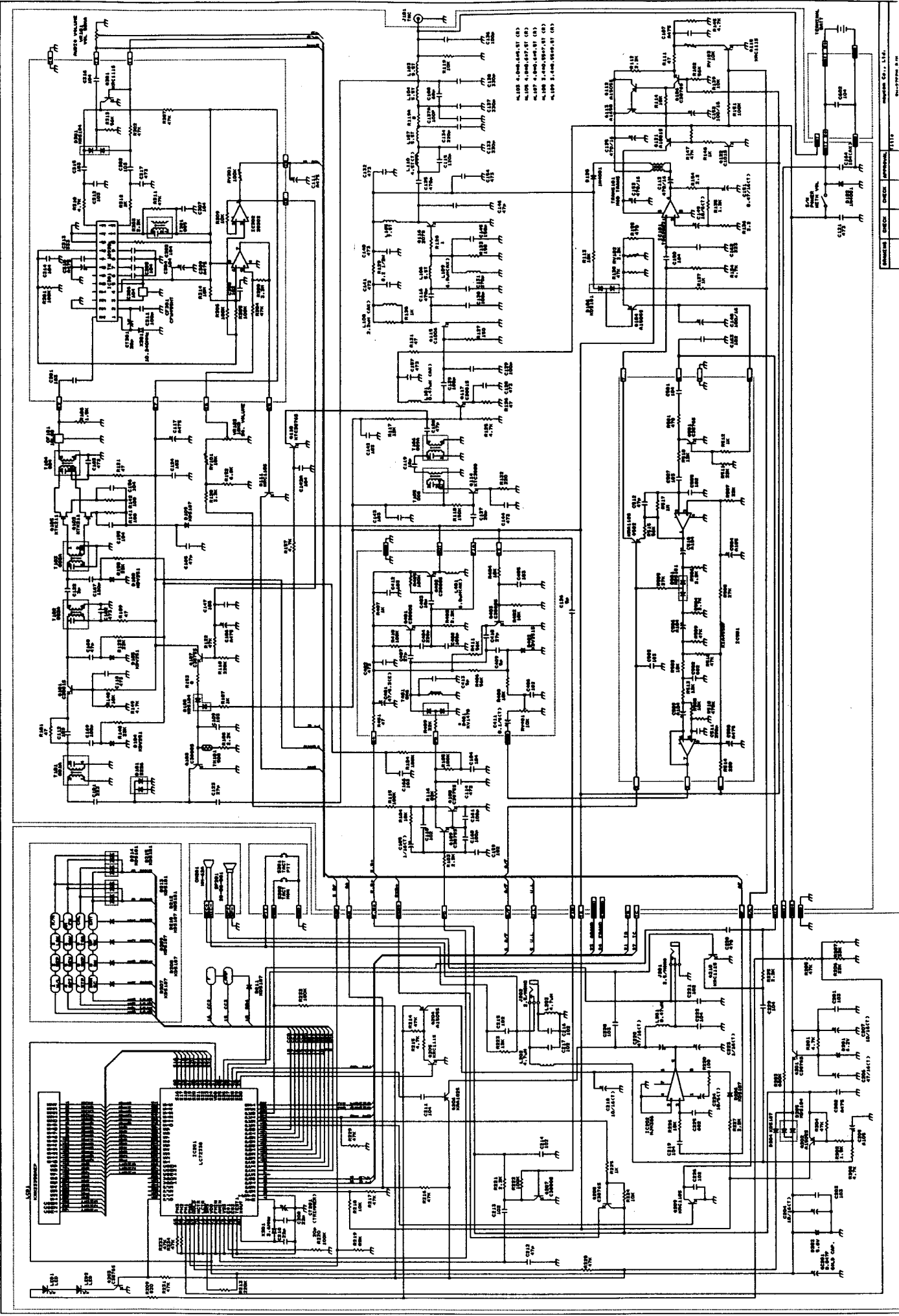

W. 100 4.000.000.001 (C)  
 W. 100 4.000.000.002 (C)  
 W. 100 4.000.000.003 (C)  
 W. 100 4.000.000.004 (C)

TOP SILK

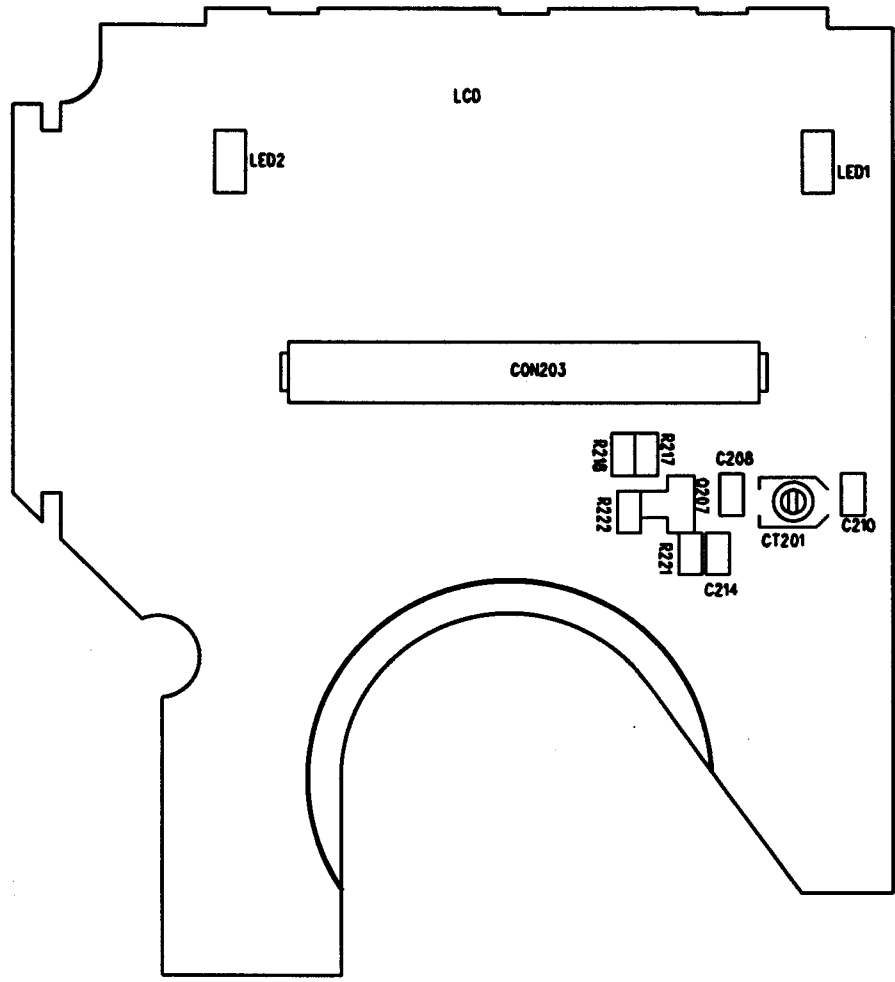

MAYCOM SH27-CPU 1996,11,29 REV.3 KIM.H.J

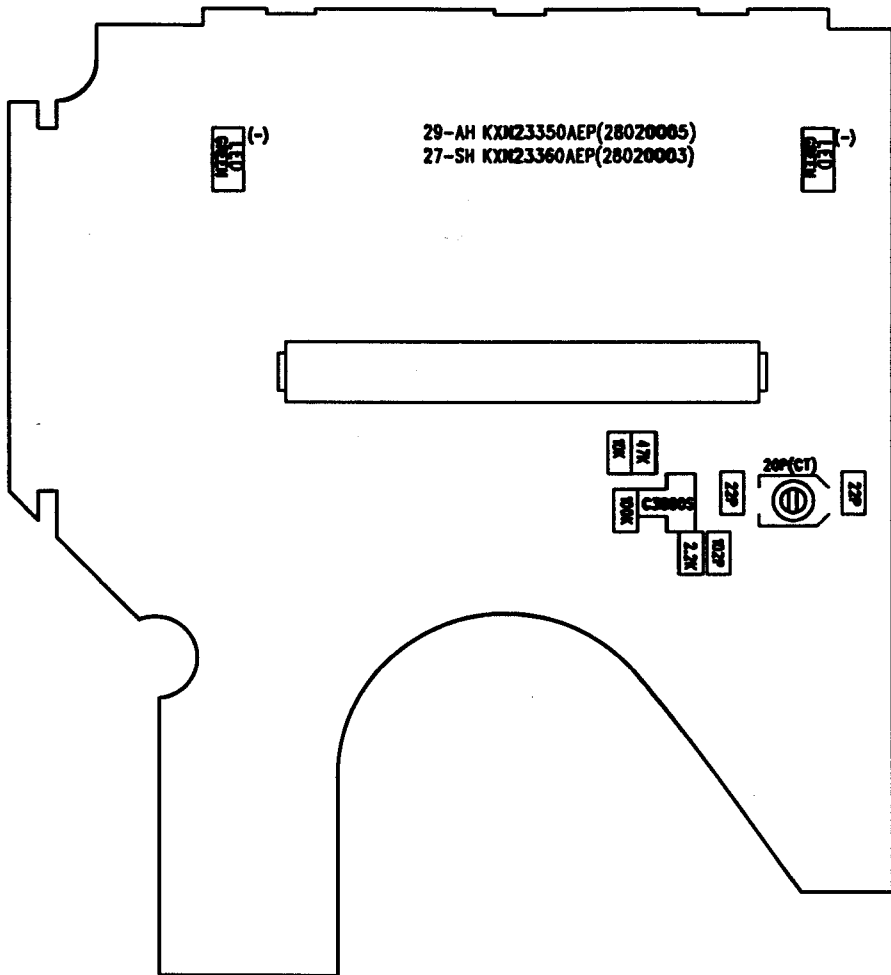

MAYCOM SH27-CPU 1996,11,29 REV.3 KIM.H.J

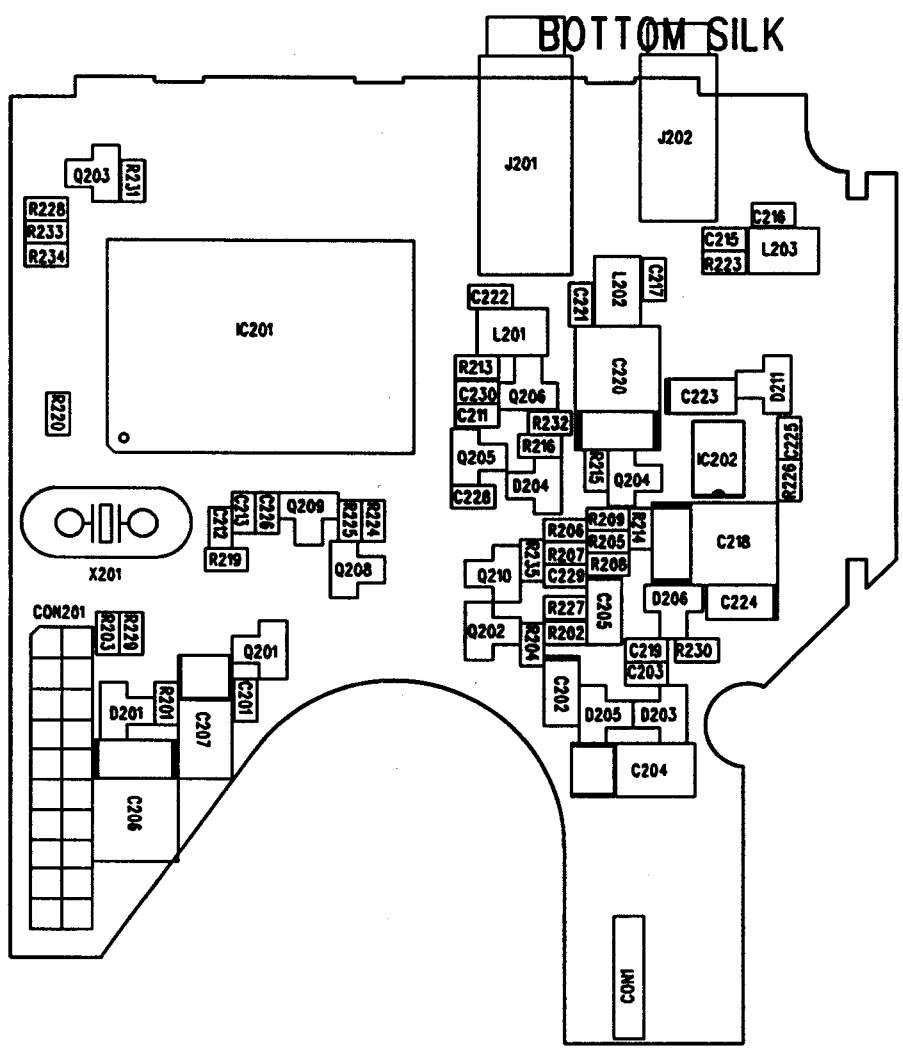

MAYCOM SH27-CPU 1986,11,29 REV.3 KIM.H.1

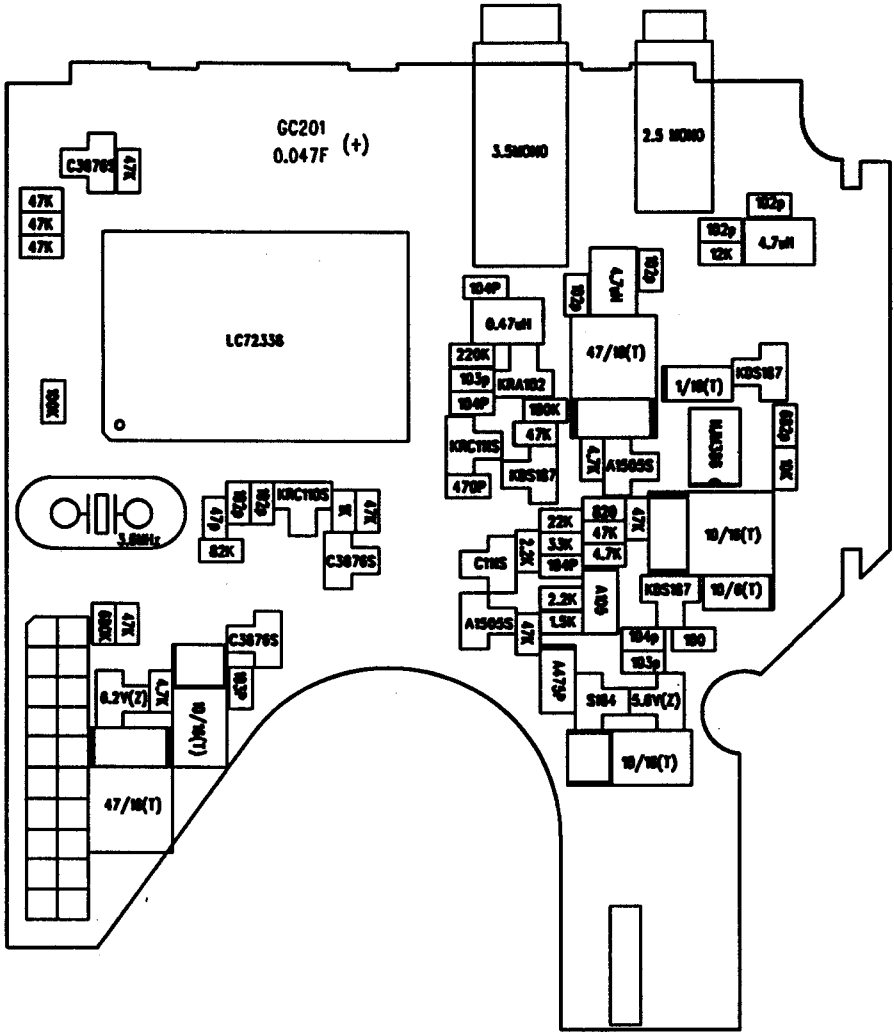

MAYCOM SH27-CPU 1000'1'2a REV.3 KIM.H.1

TOP PATTERN

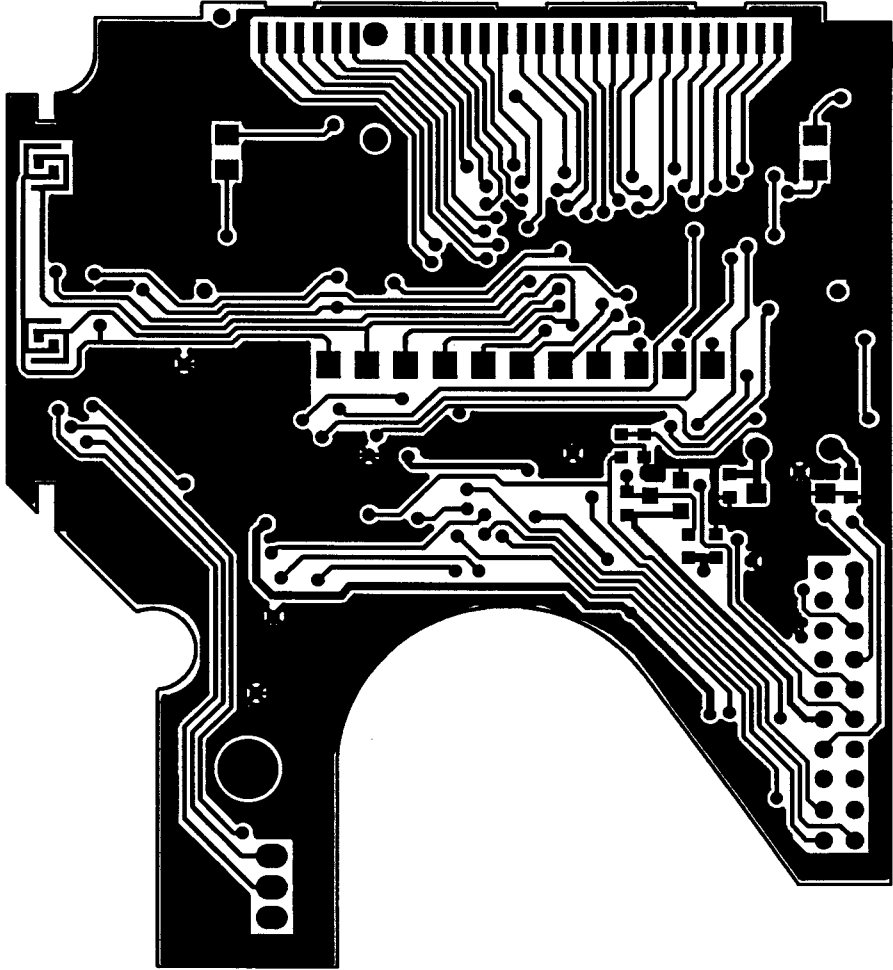

MAYCOM SH27-CPU 1996,11,29 REV.3 KIM.H.J

BOTTOM PATTERN

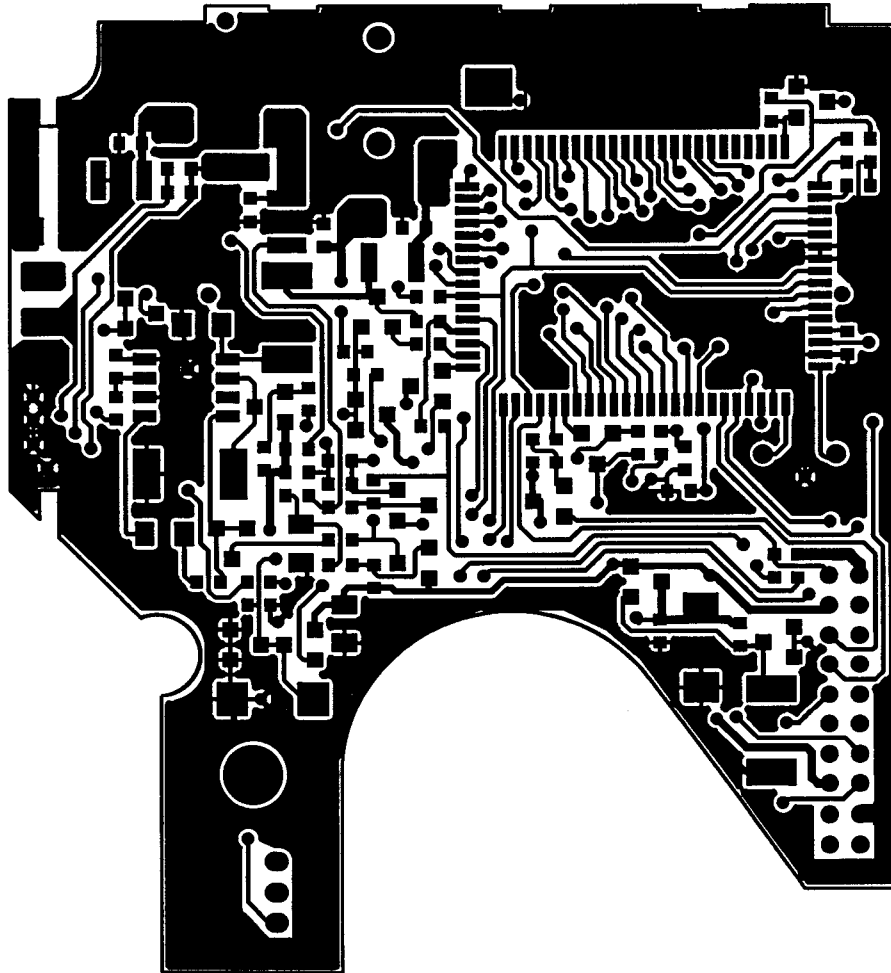

MAYCOM SH27-CPU 1996,11,29 REV.3 KIM.H.J



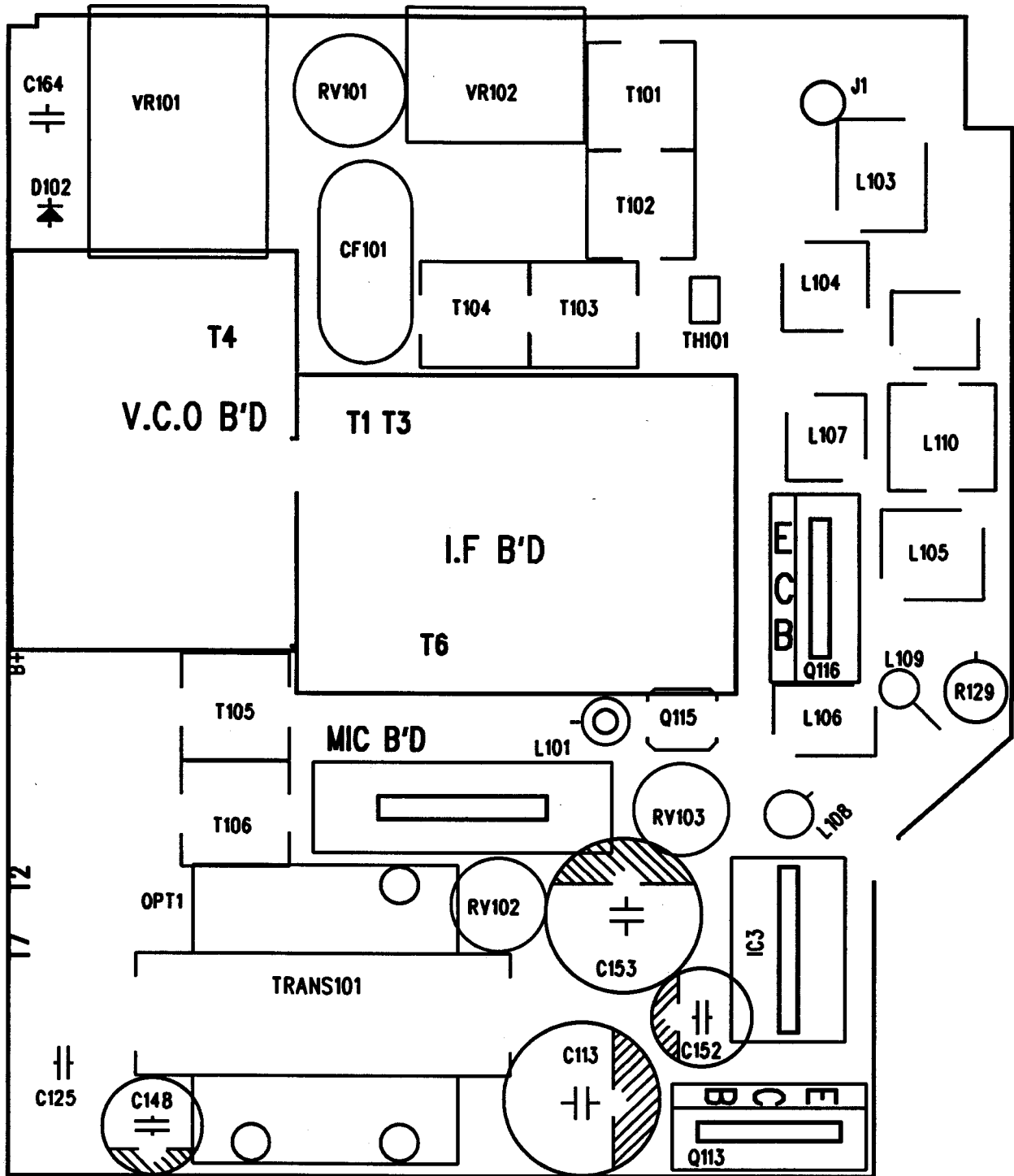

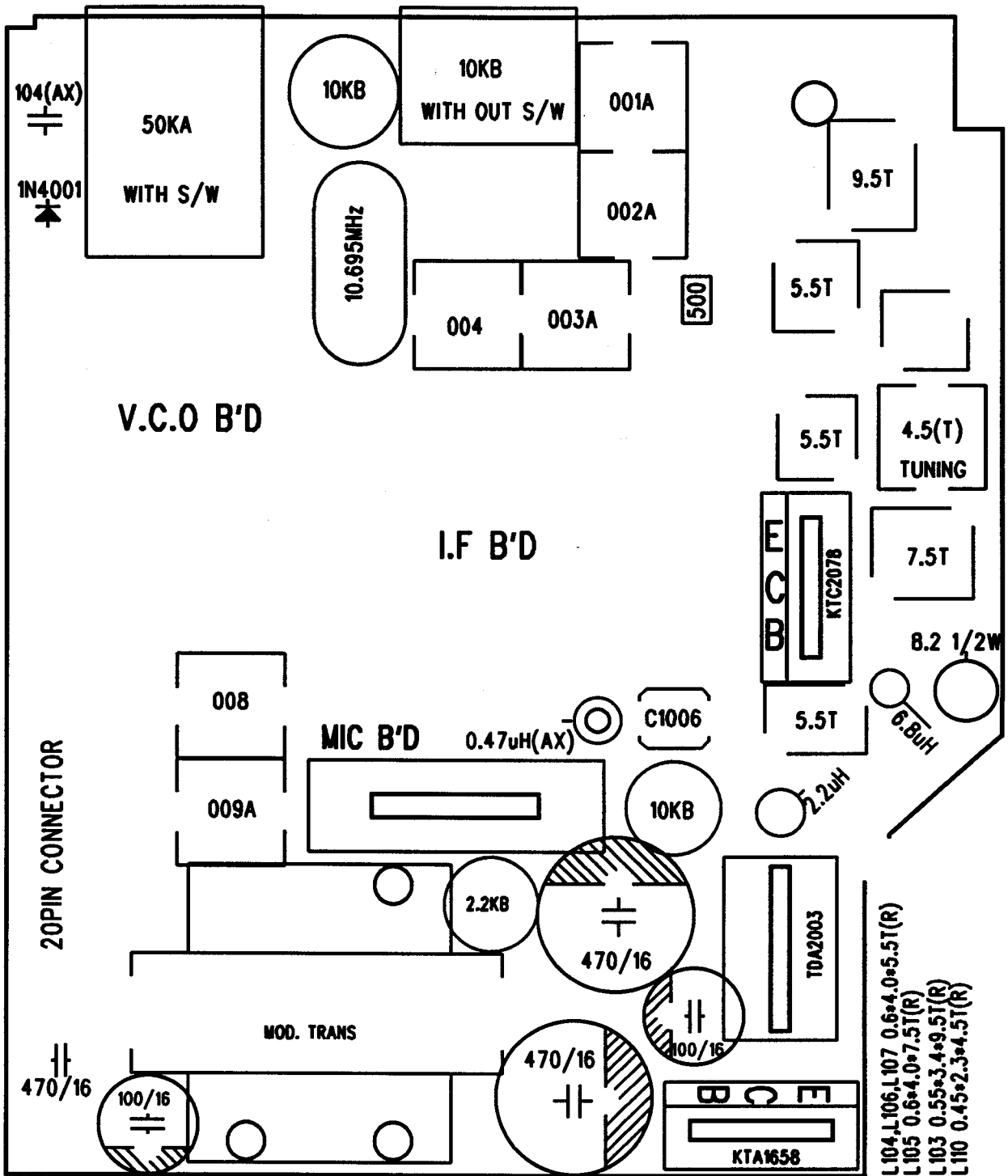





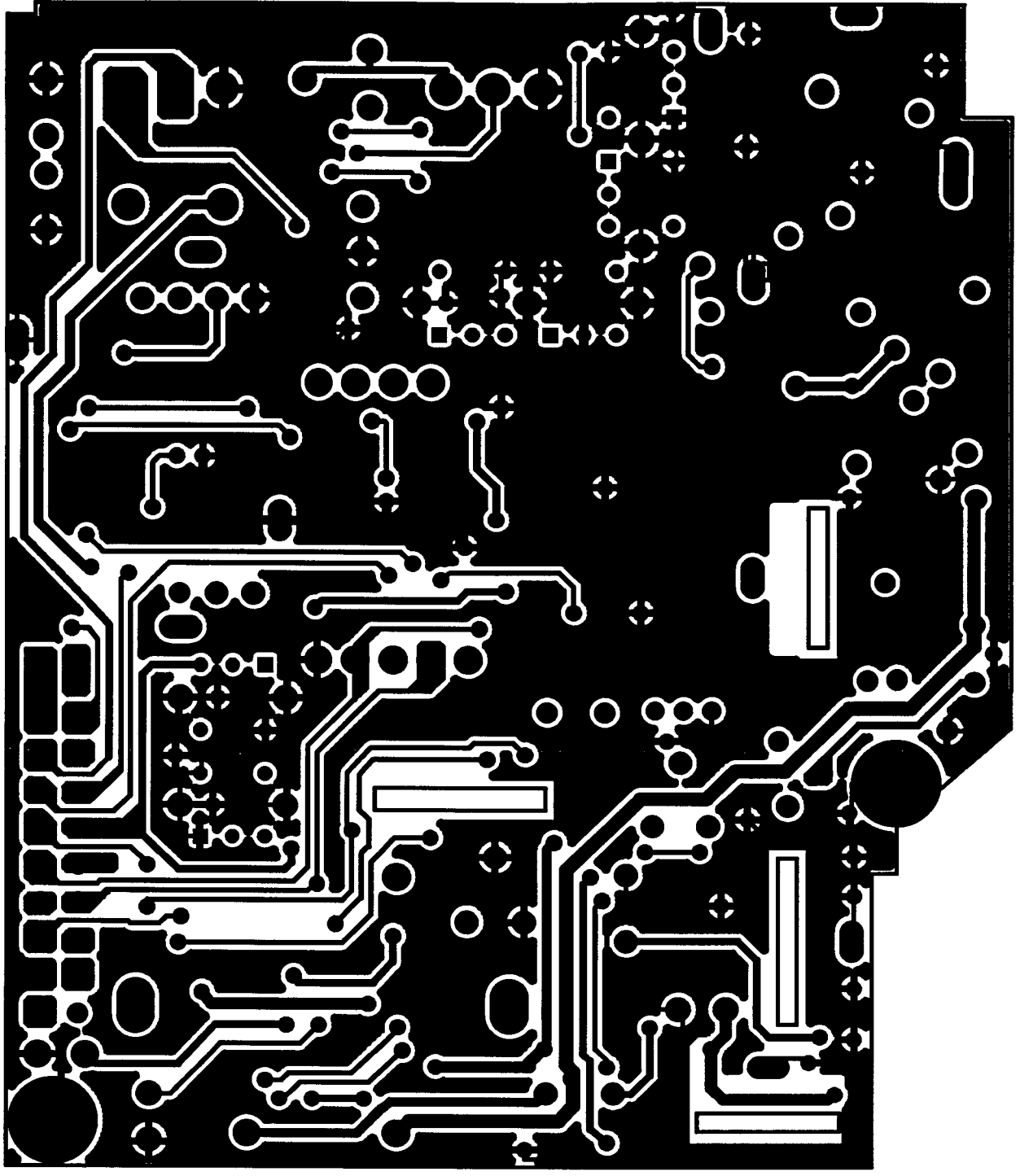

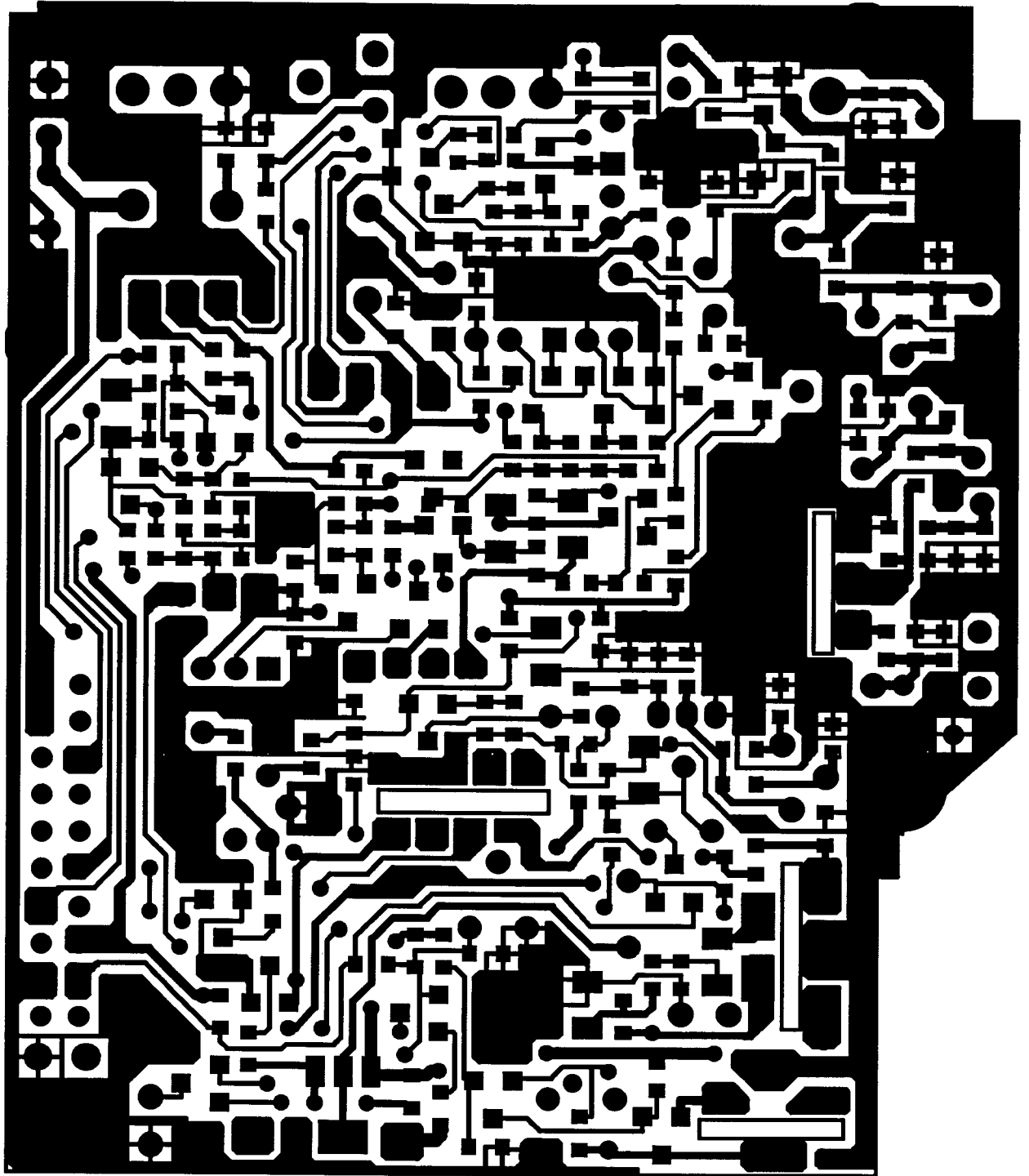

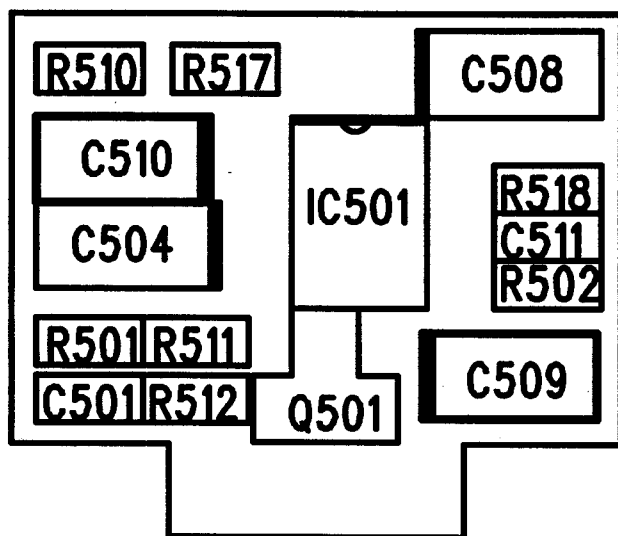

**MAYCOM**  
**AH29-MIC**

top sode silk screen

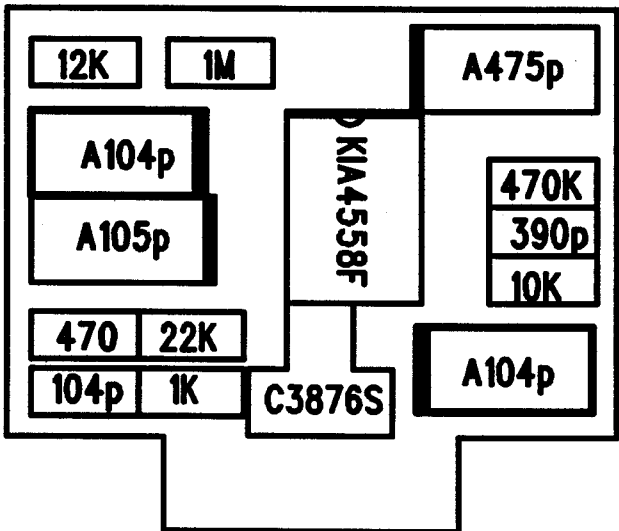

**MAYCOM**  
**AH29-MIC**



MOJYAM  
AHSA-MIC

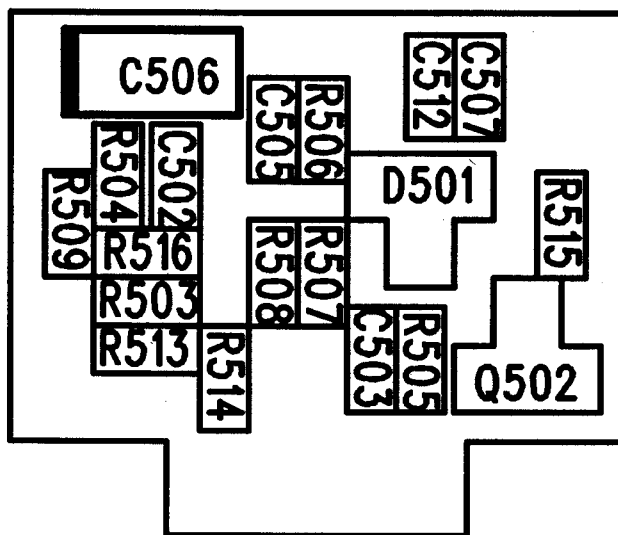

bottom side silk screen

MOJYAM  
AHSA-MIC

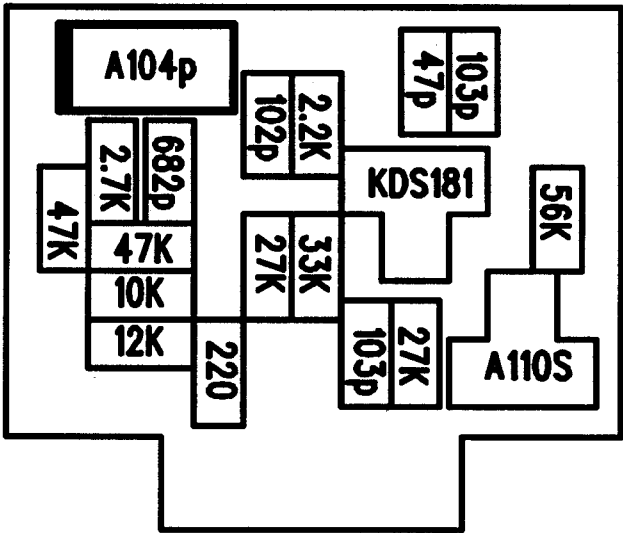

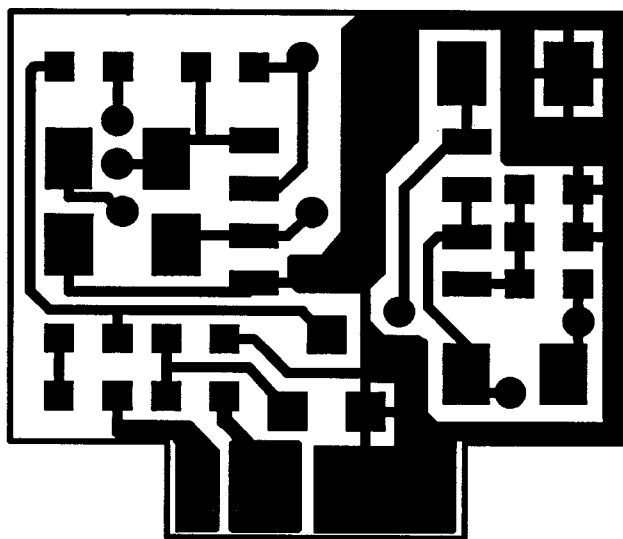

top side pattern

**MAYCOM**  
**AH29-MIC**

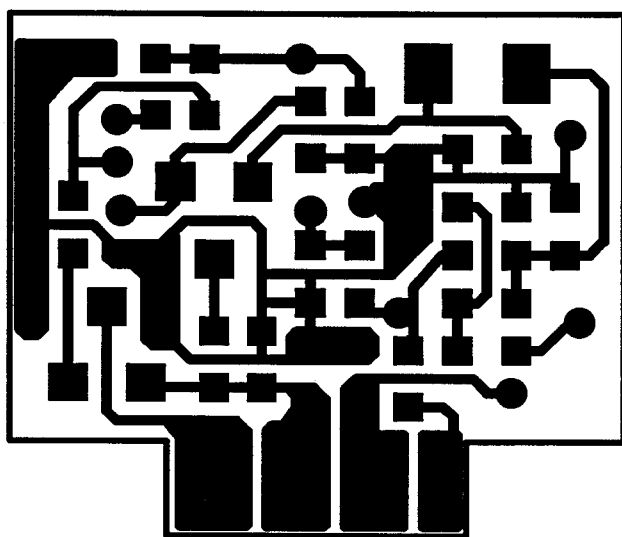

**MAYCOM**  
**AH29-MIC**

bottom side pattern

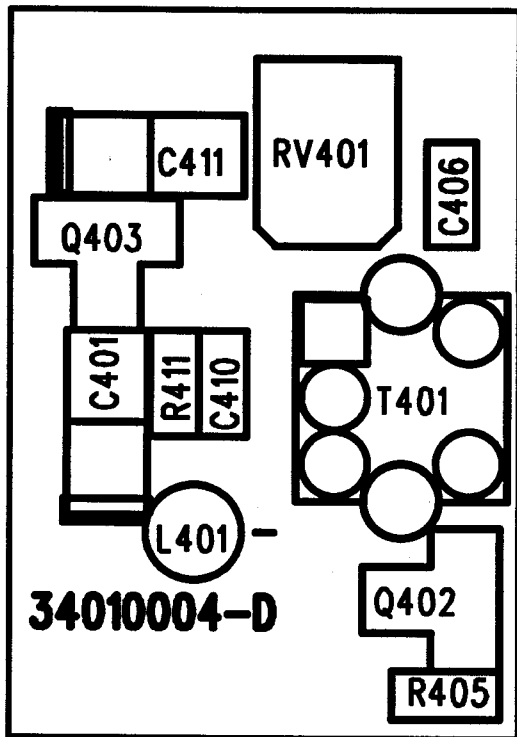

**MAYCOM**  
**AH29-VC0**

**TOP SIDE SILK SCREEN**

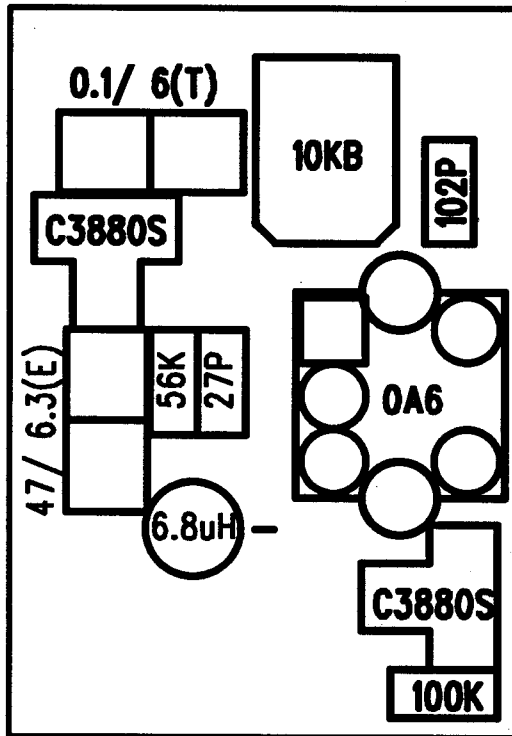

**MAYCOM**  
**AH29-VCO**

MOJYAM  
OJV-ESHA

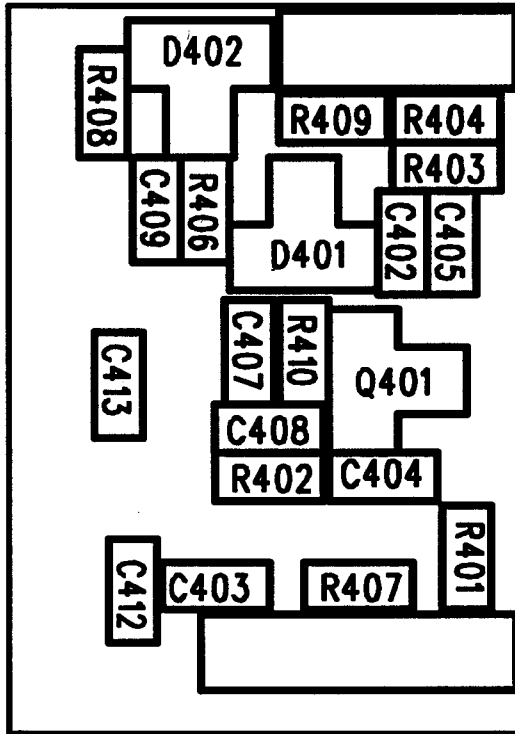

**BOTTOM SIDE SILK SCREEN**

MOJYAM  
OJY-ASHA

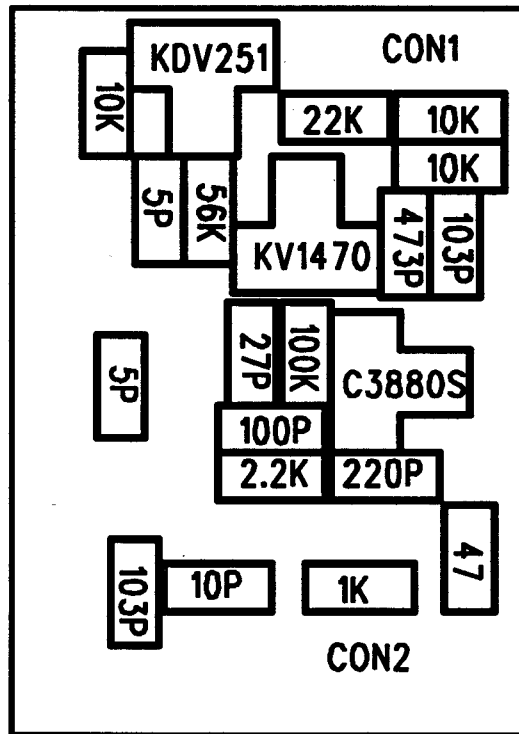



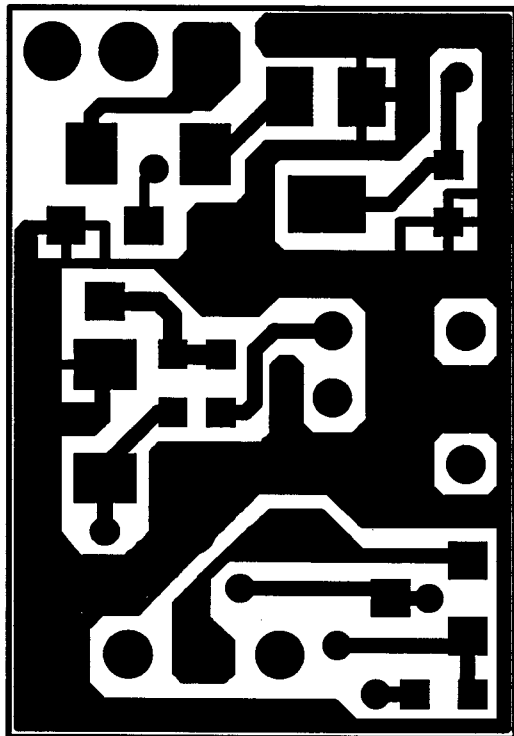

**MAYCOM**  
**AH29-VCO**

**TOP SIDE PATTERN**

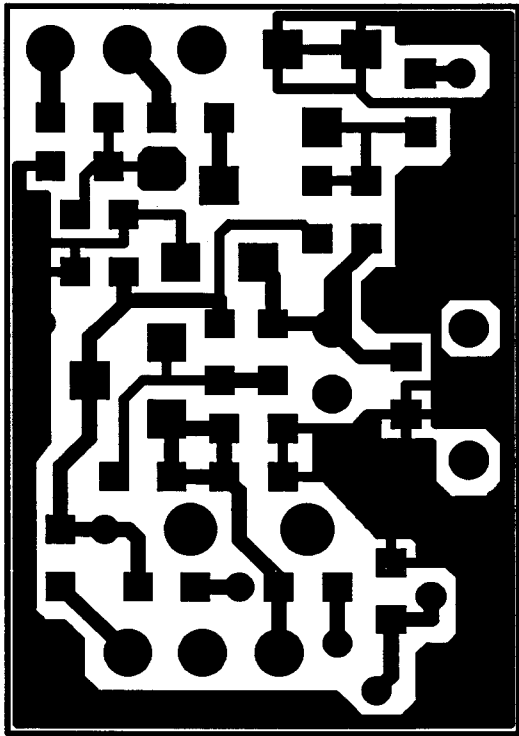

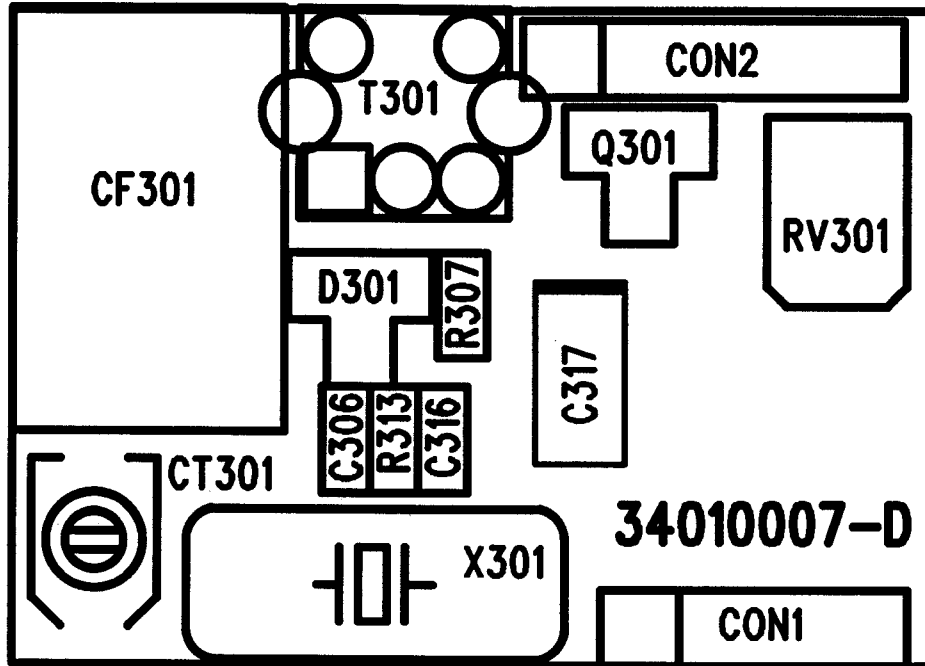

- top side silk screen -

MAYCOM

AH-27 IF

1996,07,26

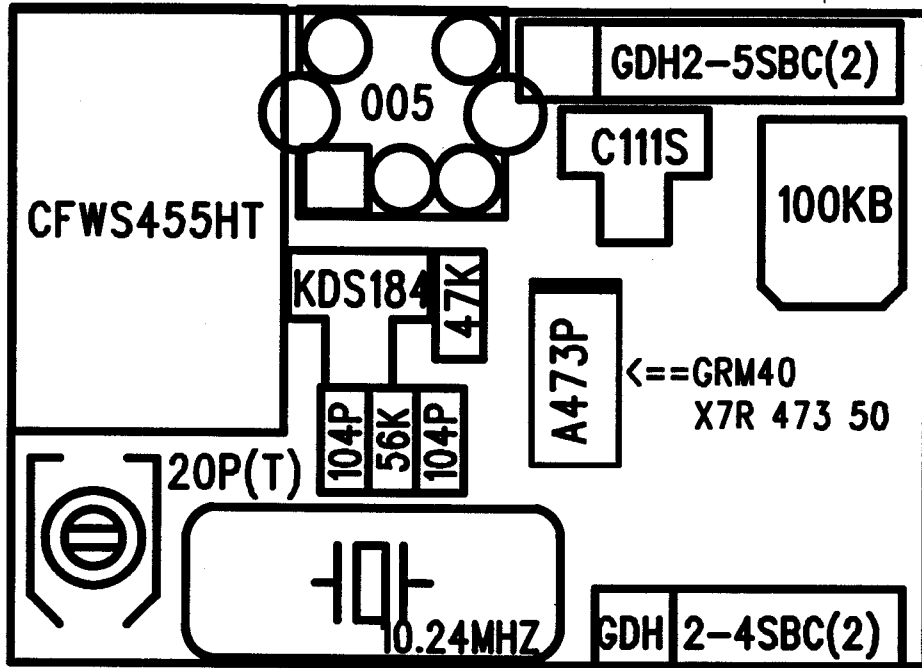

-  
 MAYCOM  
 AH-27 IF  
 1996,07,26

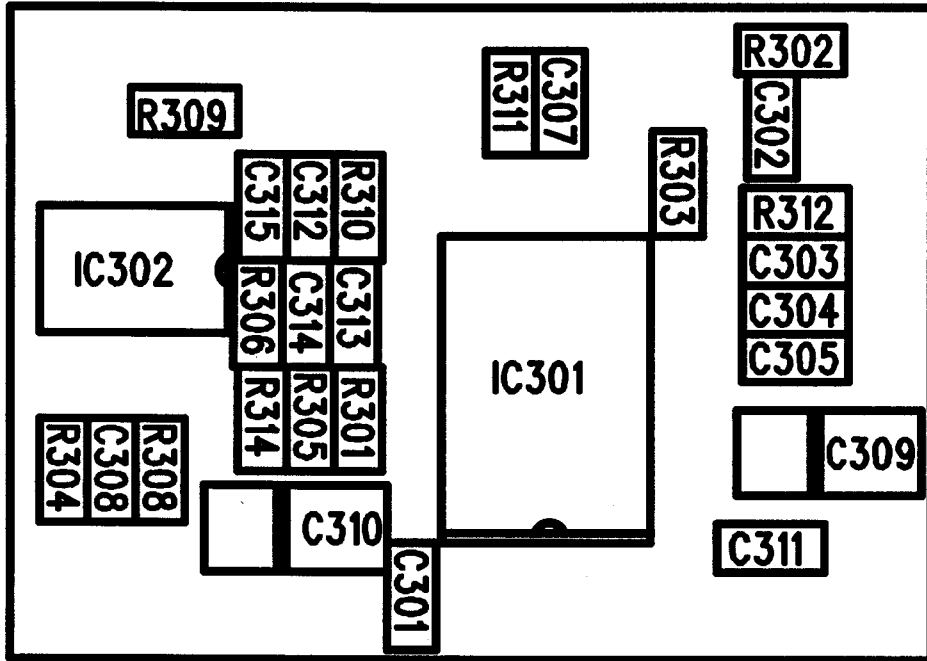

- bottom side silk screen -

1998, 07, 28  
 AH-SJ IF  
 MAYCOM



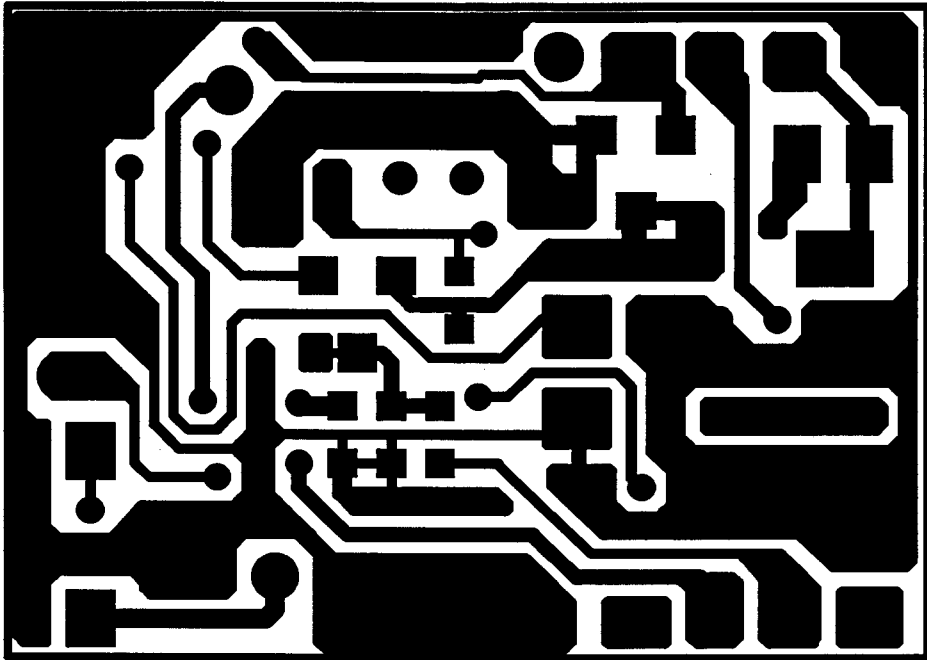

- top side pattern -

MAYCOM

AH-27 IF

1996,07,26

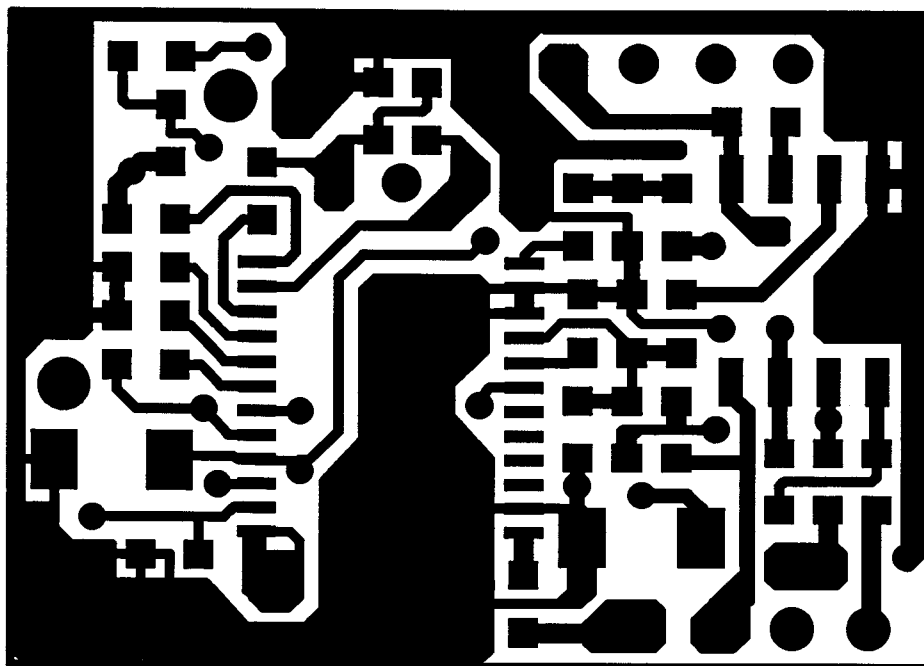

- bottom side pattern -

MAYCOM  
AH-27 IF  
1996,07,26



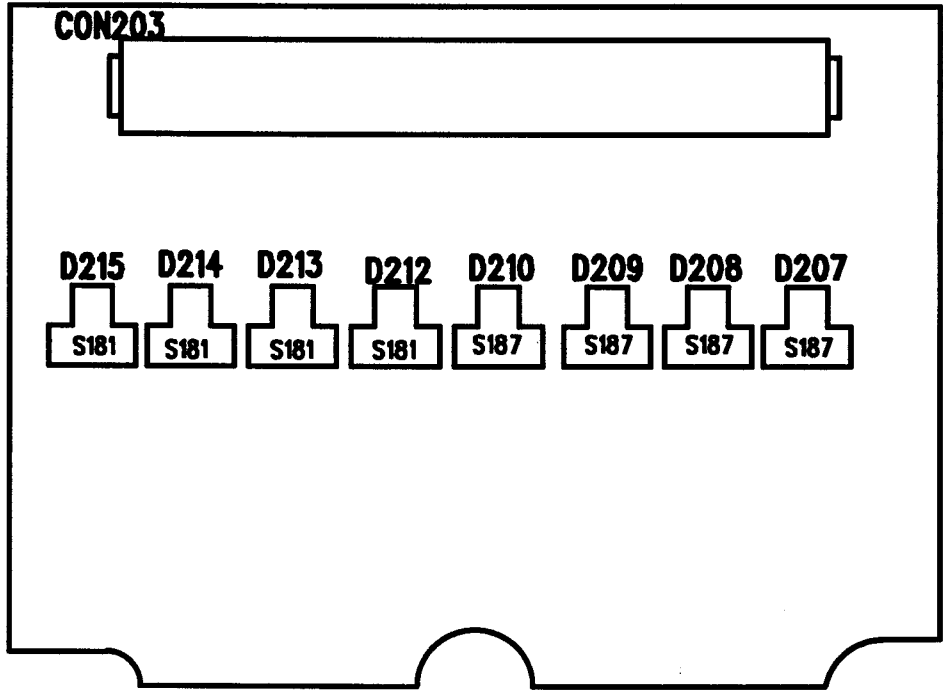

MAYCOM AH-2a(KEY)

BOTTOM SILK

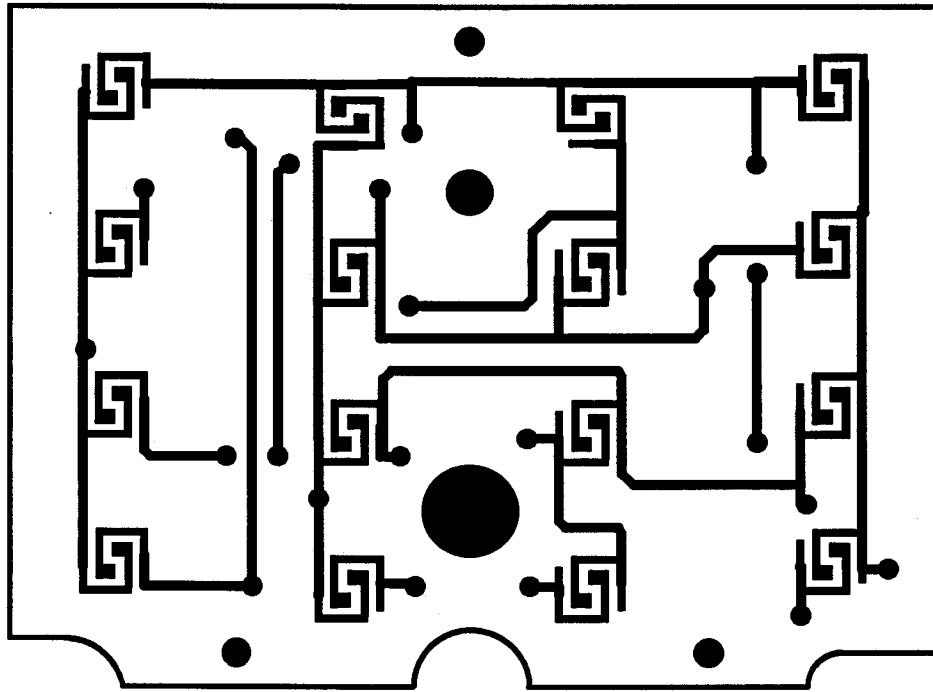

MAYCOM SH-27(KEY)

1996,03,06

REV.0

H.J.KIM

TOP PATTERN

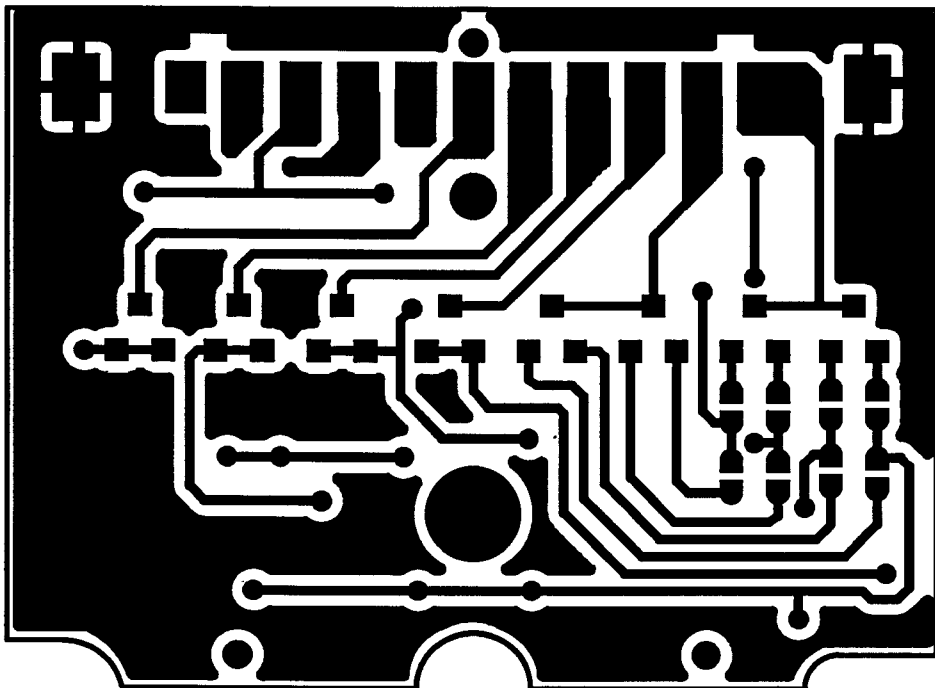

MAYCOM SH-27(KEY)  
1996,03,06  
REV.0  
H.J.KIM BOTTOM PATTERN

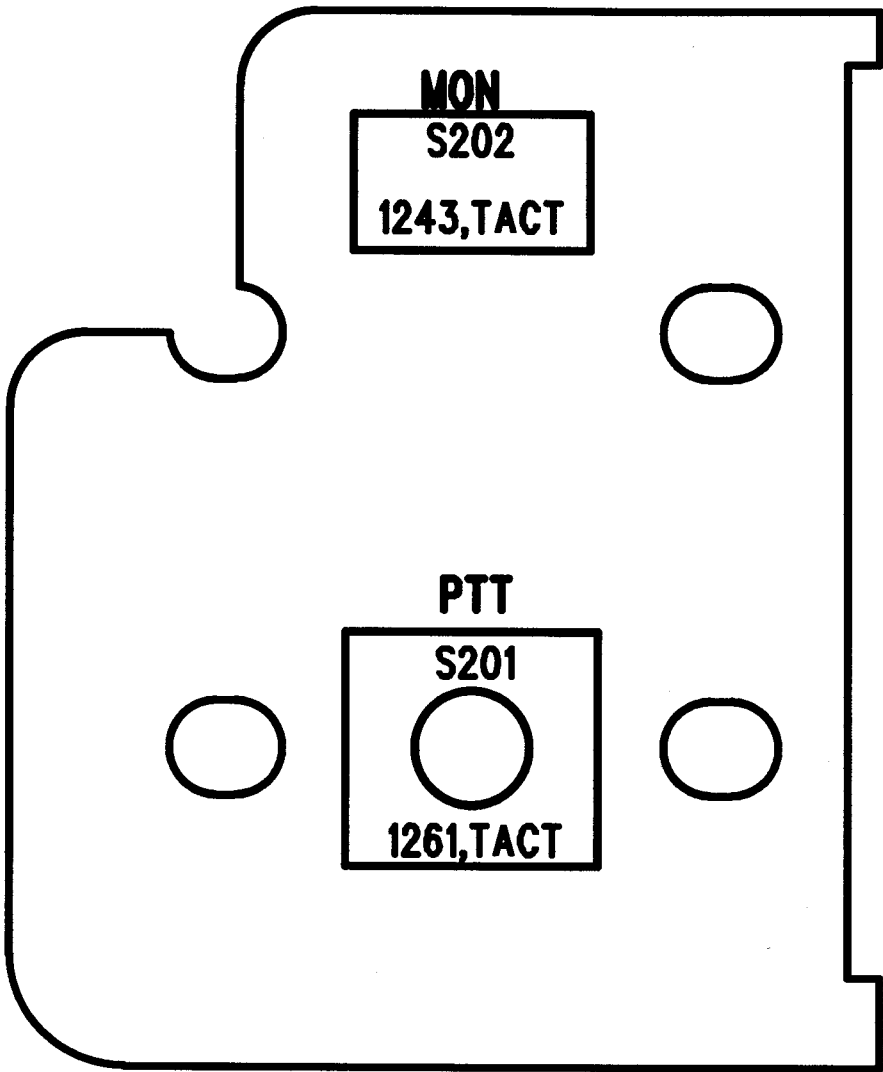

MAYCOM  
AH29-PTT

TOP SILK SCREEN

MAYCOM  
AH29-PTT

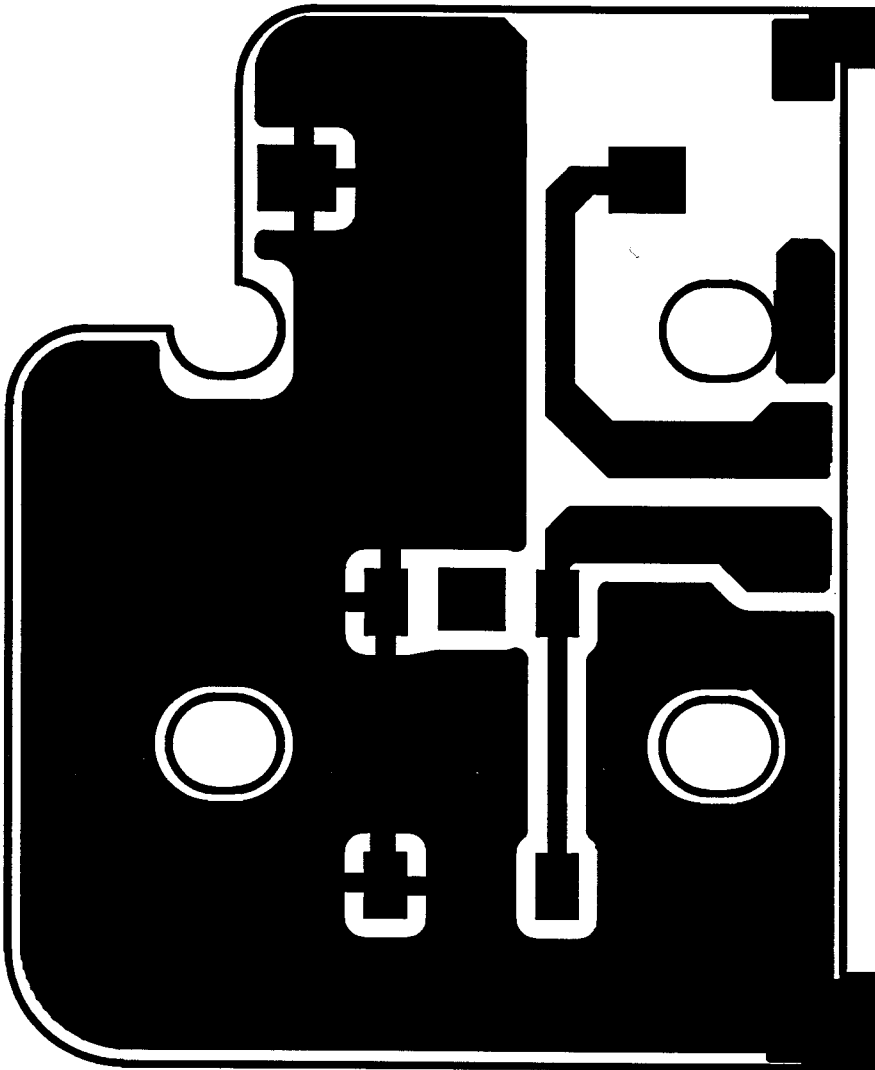

TOP PATTERN

MAYCOM  
AH29-PTT

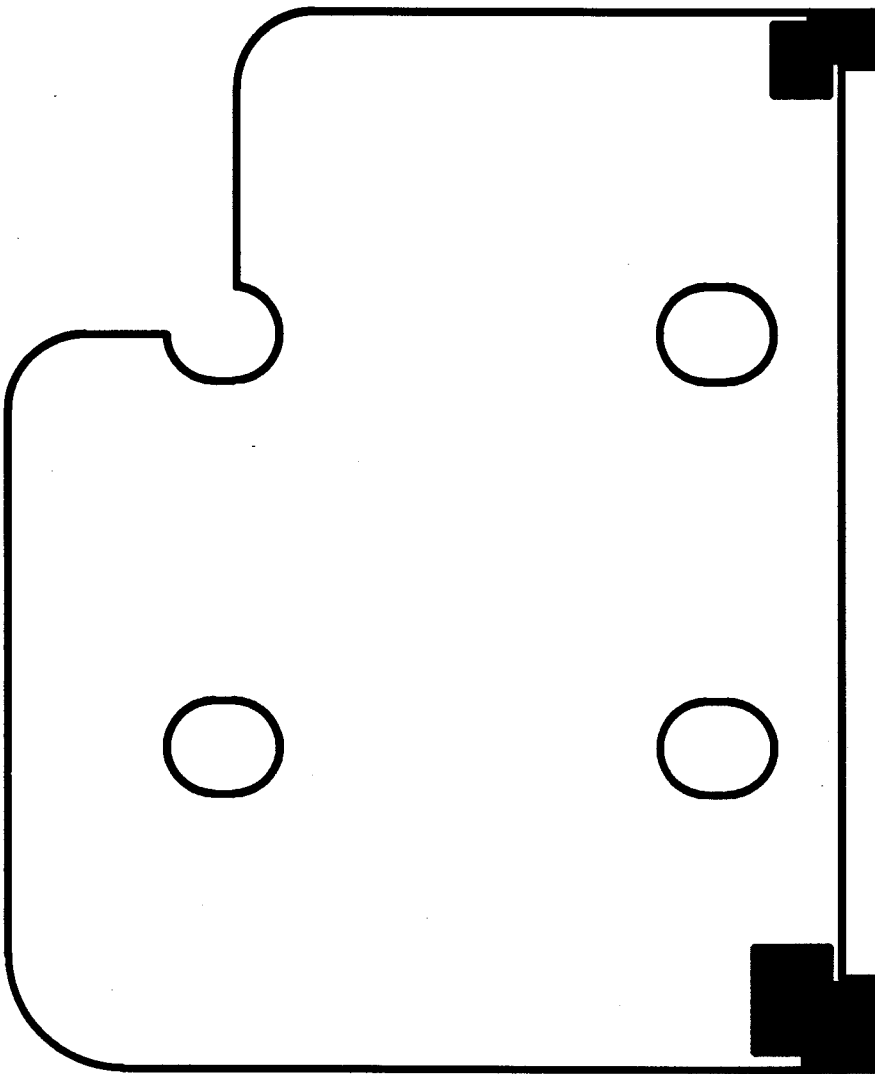

BOTTOM PATTERN

TOP PATTERN

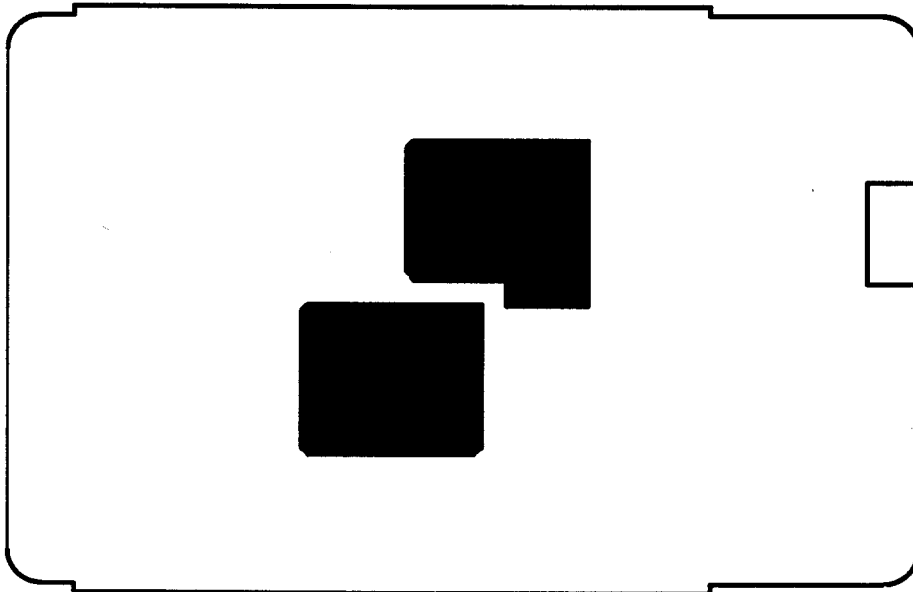

MAYCOM  
SH27-TERMINAL  
1995,09,14

BOTTOM PATTERN

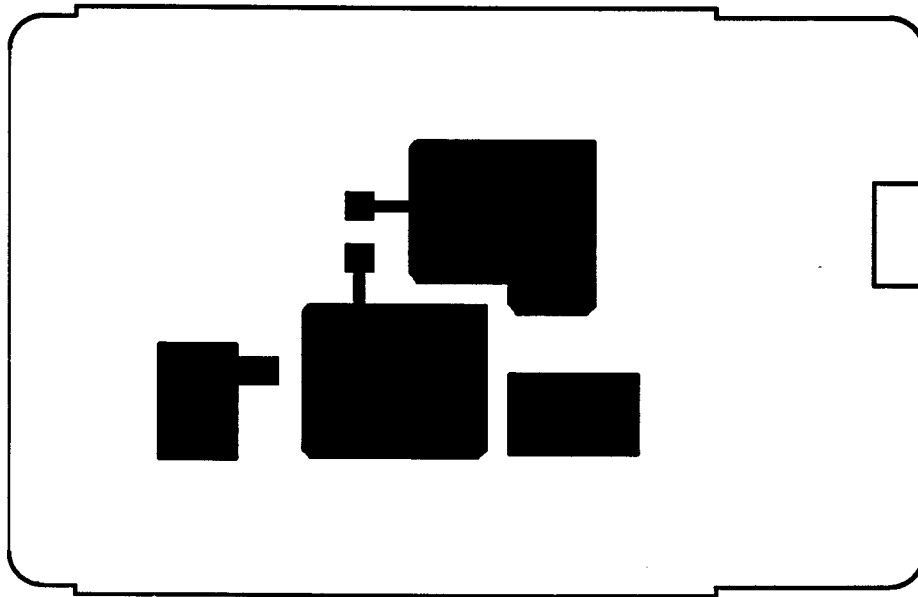

MAYCOM

SH27-TERMINAL

1995,09,14