

S/M No. : FF11500010

Service Manual

Refrigerator

Model: FF-115

DAEWOO



DAEWOO ELECTRONICS CO., LTD.

1. Specification -----1

2. External view -----2

3. Wire diagram -----3

4. Name of parts-----4

5. Air flow diagram-----5

6. Refrigerant cycle diagram -----6

7. Machine room view and part list-----7

8. Main components -----8

9. Door color specification ----- 11

10. Exploded view and parts-----14

1. SPECIFICATION

MODEL NAME		FF-115
Refrigerant	R12	110g
	R134a	80g ~ 90g
Cooling System		Fan Cooling Convection Type
Refrigeration System		Air Forced Convection
Defrost System		Defrost Heating Type
Defrost Operation		Automatic Start & Stop
Cold Control		Adjustable Dial
Capacity	Freezer	85 ℓ
	Refrigerator	-
	Total	85 ℓ
External Dimension	Height	955mm
	Width	485mm
	Depth	530mm
Net Weight		32Kg

2. EXTERNAL VIEWS

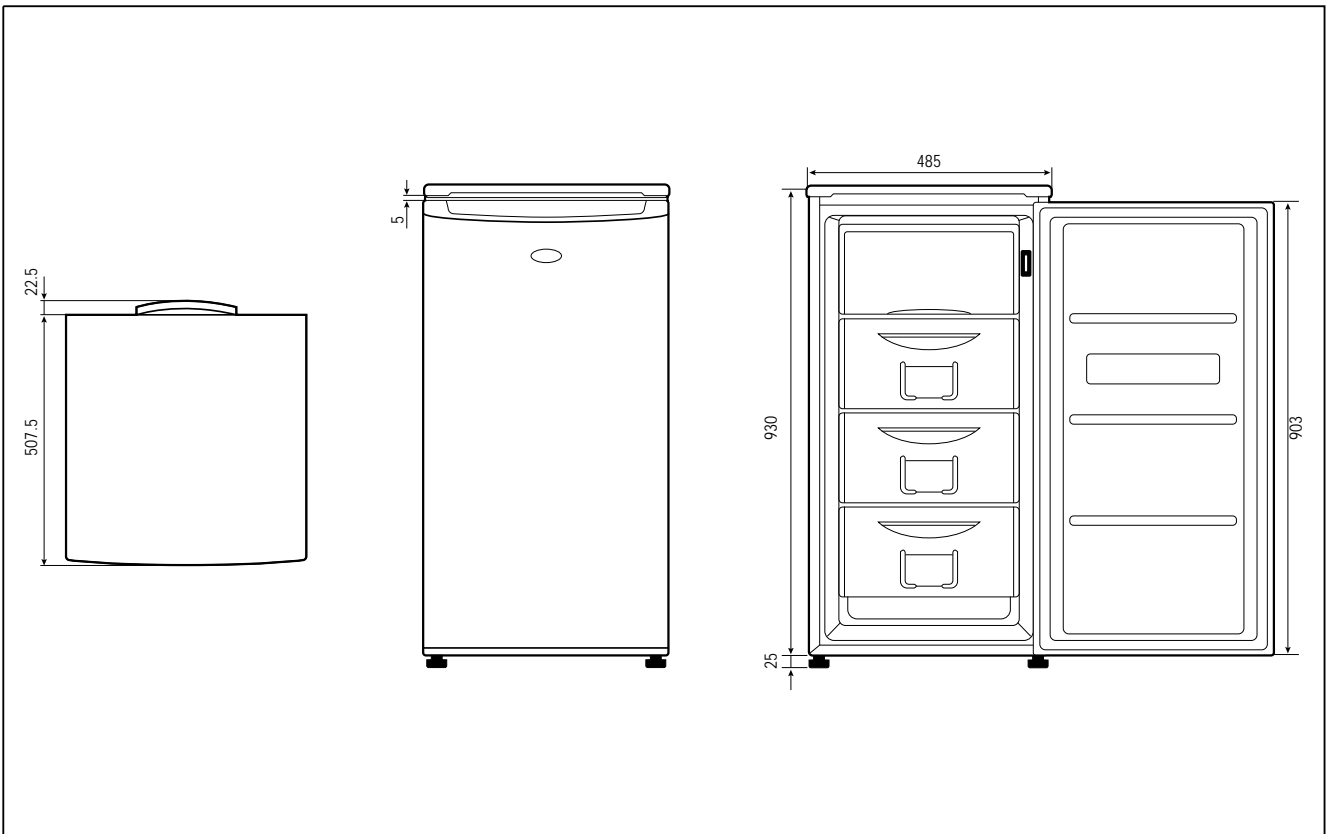

3. WIRE DIAGRAM

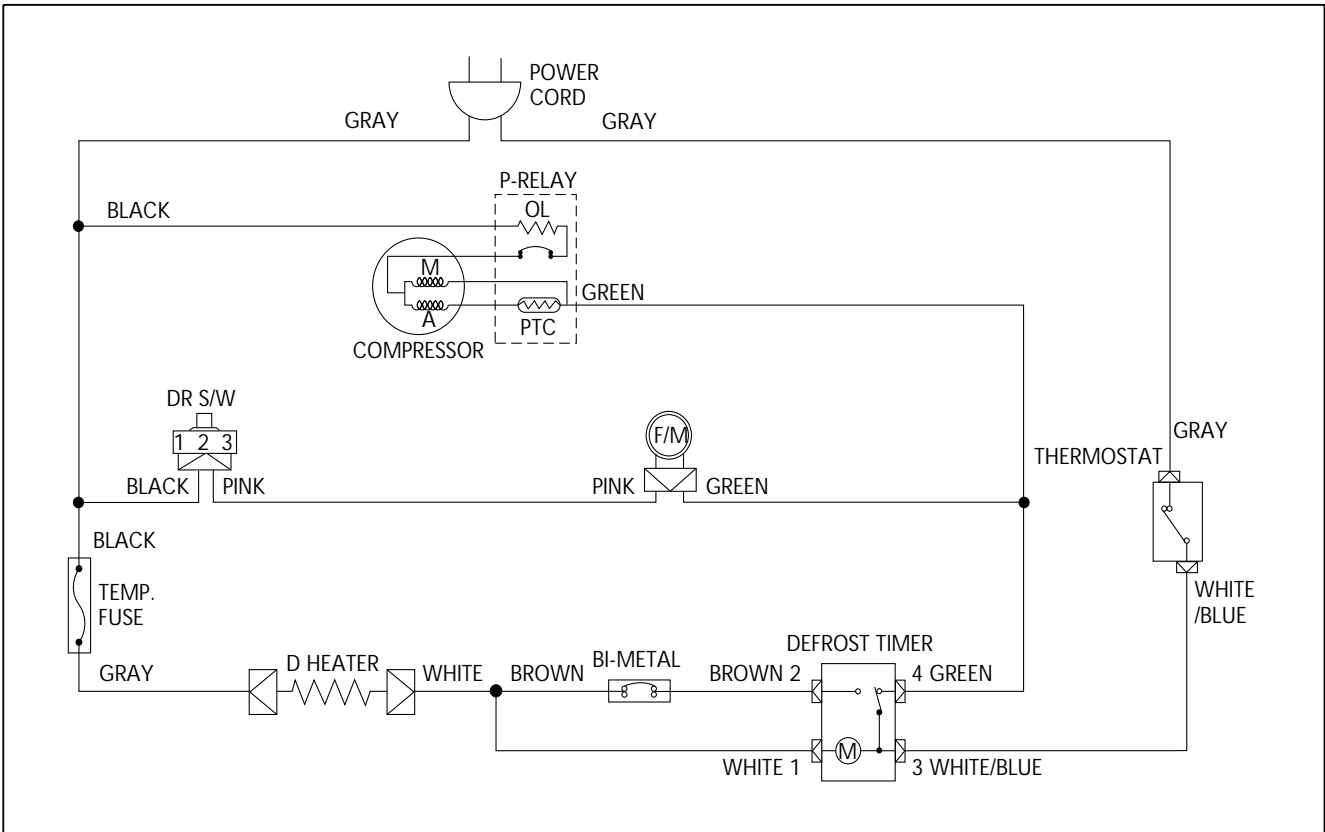

4. NAME OF PARTS

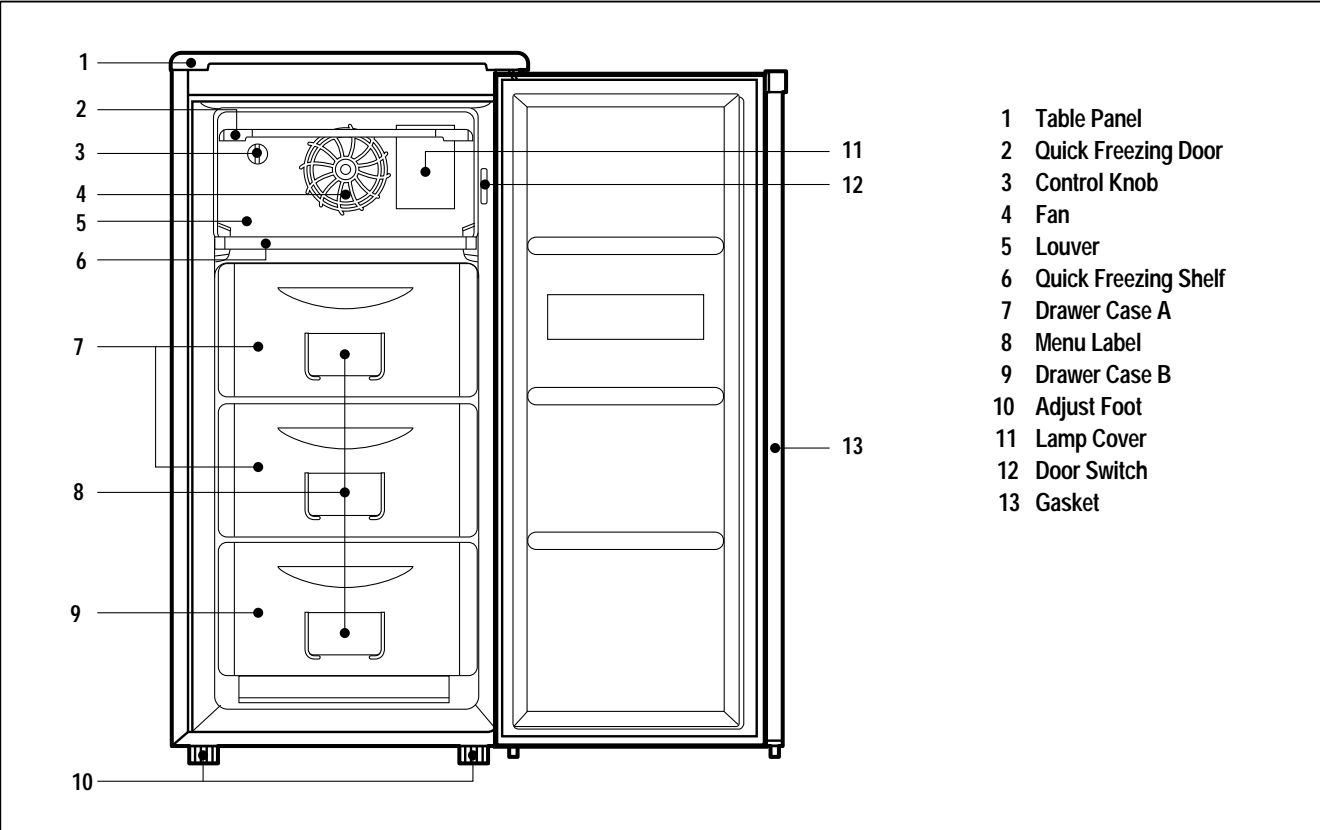

5. AIR FLOW DIAGRAM

Freezer room

Do not put in any bottle such as beer or beverage because it can be frozen and broken.

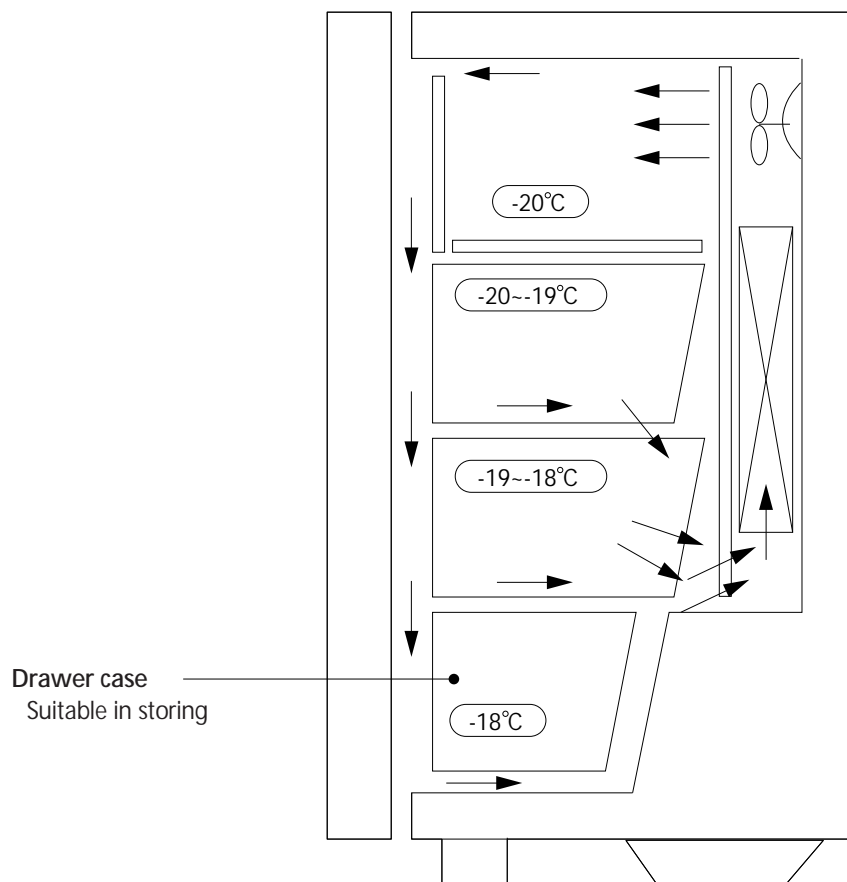

6. REFRIGERANT CYCLE DIAGRAM

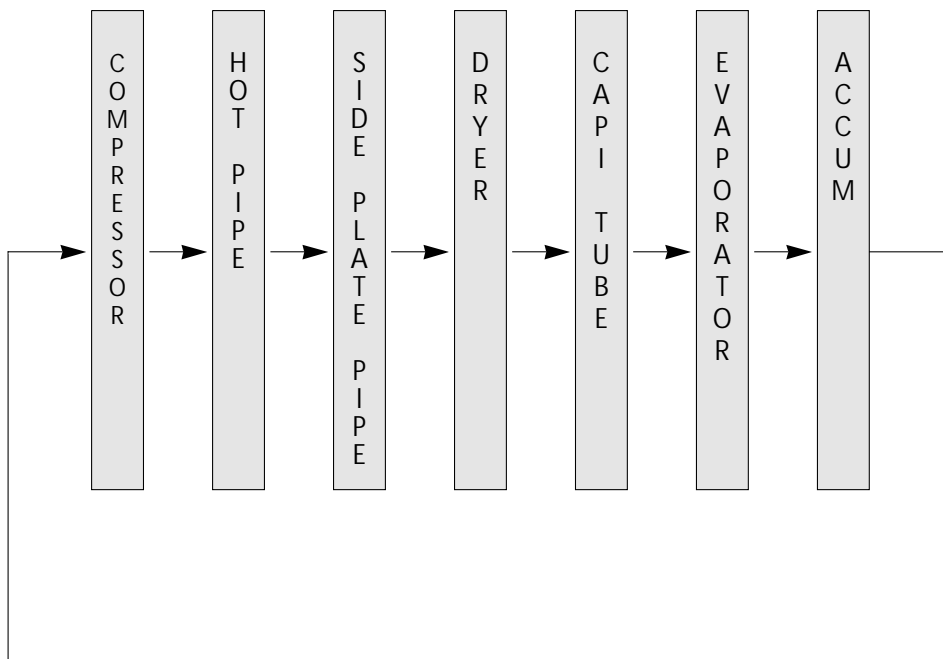
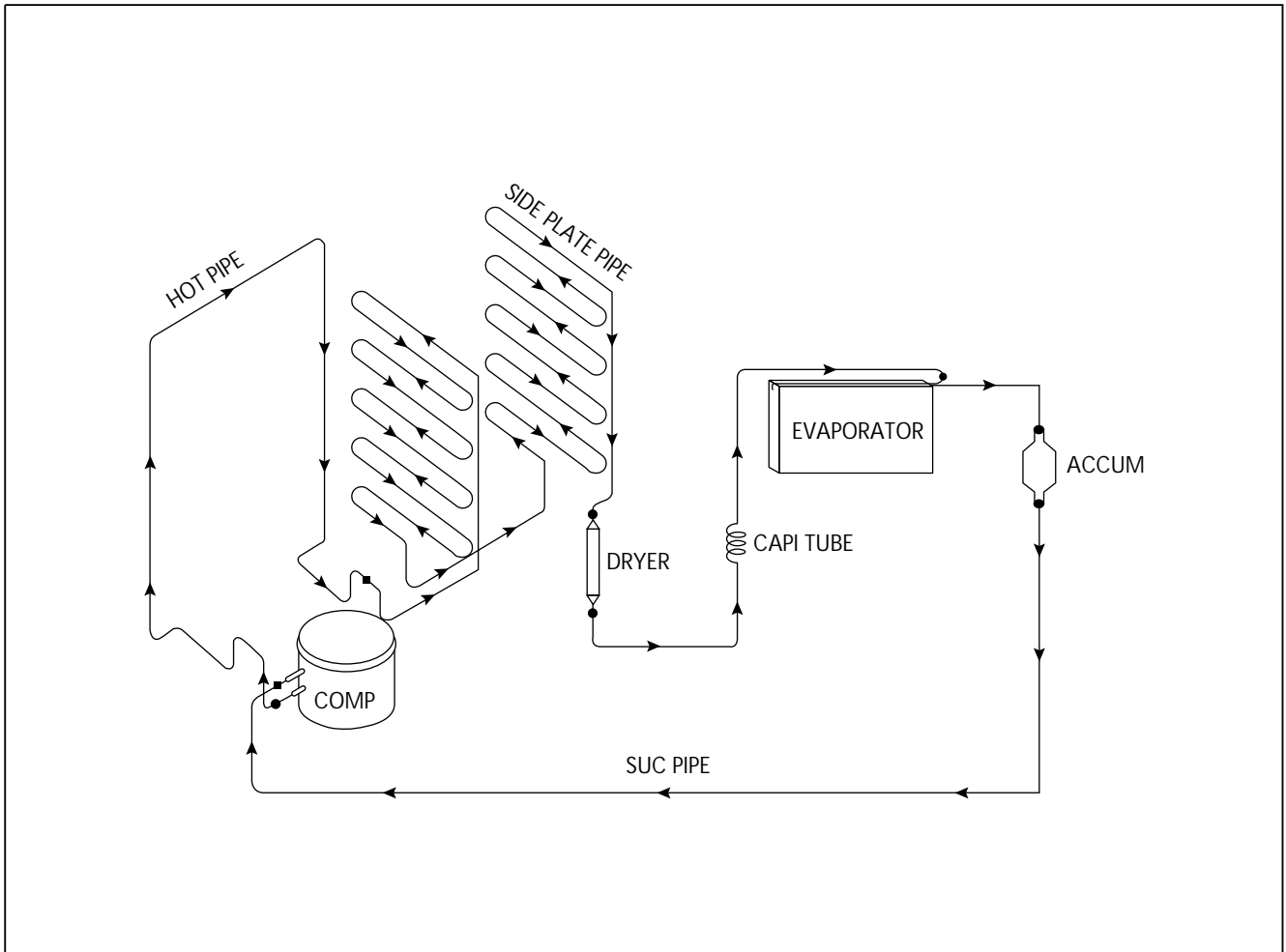

7. MACHINE ROOM VIEW AND PART LIST

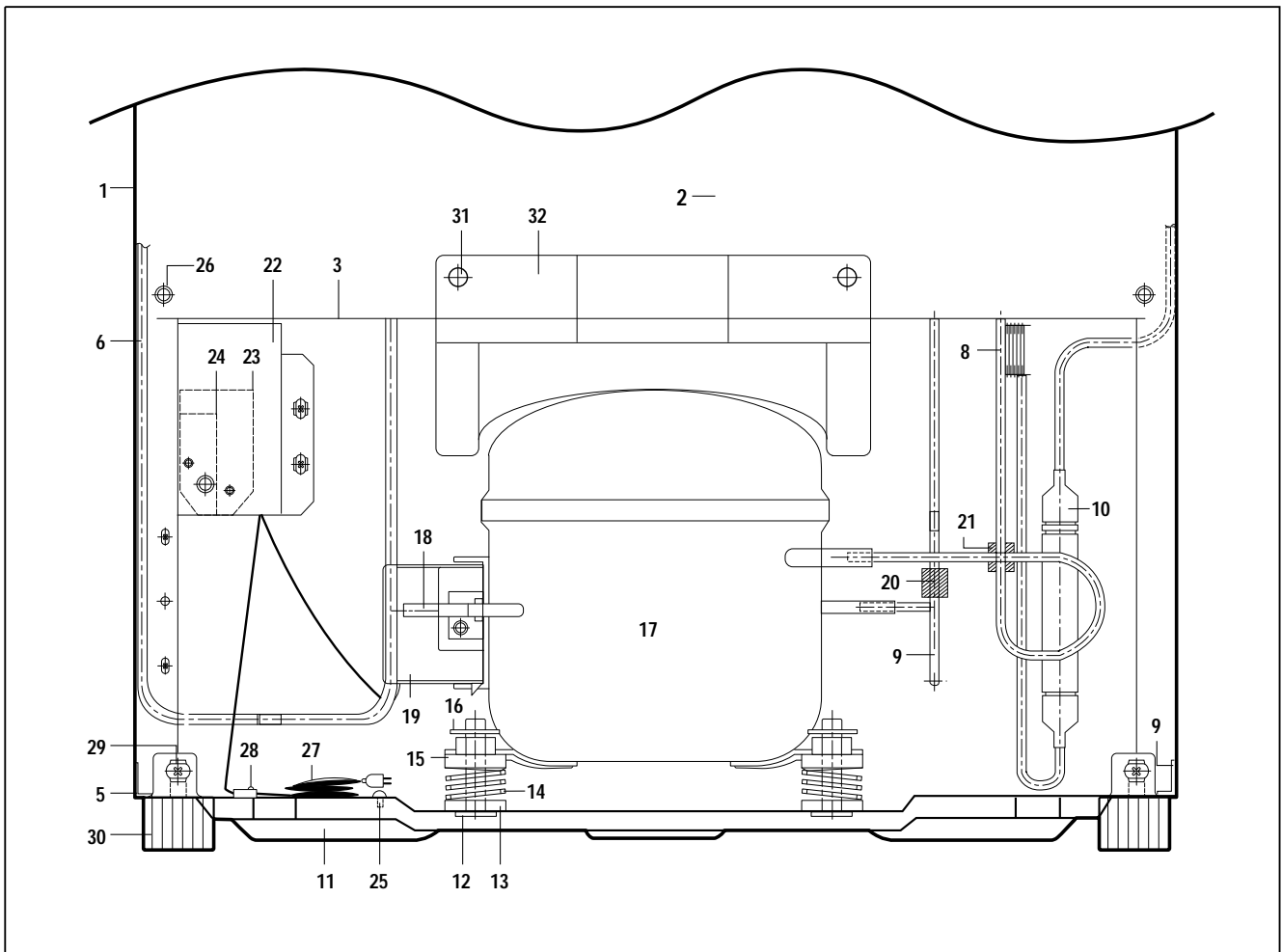

NO	PART NAME	NO	PART NAME	NO	PART NAME
1	CABINET AS	12	FIXTURE COMP BOLT	23	TIMER
2	COVER CAB AS	13	ABSORBER COMP RUB (B)	24	CAPACITOR RUNNING
3	BASE CAB AS	14	ABSORBER COMP SPG	25	SCREW MACHINE
4	REINFORCE *L	15	ABSORBER COMP RUB (A)	26	SCREW TAPPING
5	REINFORCE *R	16	WASHER COMP *T	27	CORD POWER
6	PIPE CON	17	COMPRESSOR	28	SCREW TAPPING
7	PIPE HOT	18	PIPE SERVICE	29	BOLT HEX
8	PIPE SUC AS	19	SWITCH P-RELAY AS	30	FOOT ADJ *L
9	PIPE AUX CONN	20	VIBRATIONPROOF MASS (B)	31	FIXTURE VAPORI
10	DRYER AS	21	VIBRATIONPROOF MASS (A)	32	CASE VAPORI
11	BASE COMP	22	BOX POWER		

8. MAIN COMPONENTS

1. COMPRESSOR

Refrigerant	R12							
Voltage	100V/50,60Hz	110V/60Hz	115, 120V/60Hz	127V/60Hz	220V/50Hz	220V/60Hz	230V/50Hz	240V/50Hz
Comp. model	X	X	X	X	SL17J-5	PL19J-4	X	SL17J-5
Part code	X	X	X	X	3954117380	3956119340	X	3954117380
Strating type	X	X	X	X	RSIR	RSCR	X	RSIR
Refrigerant	X	X	X	X	110 g	110 g	X	110 g

Refrigerant	R134a							
Voltage	100V/50,60Hz	110V/60Hz	115, 120V/60Hz	127V/60Hz	220V/50Hz	220V/60Hz	230V/50Hz	240V/50Hz
Comp. model	HEL19J	HEL17J-3	X	X	HSL19J-5	X	X	HSL19J-5
Part code	3953119E00	3953117E30	X	X	3954119E50	X	X	3954119E50
Strating type	RSCR	←	X	X	RSIR	X	X	RSIR
Refrigerant	90 g	85 g	X	X	80 g	X	X	80 g

2. RELAY ASSEMBLY

Refrigerant	R12							
Voltage	100V/50,60Hz	110V/60Hz	115, 120V/60Hz	127V/60Hz	220V/50Hz	220V/60Hz	230V/50Hz	240V/50Hz
Relay model	X	X	X	X	174SHBYY-52	129SHBYY-52	X	174SHBYY-52
Part code	X	X	X	X	3018104810	3018104841	X	3018104810

Refrigerant	R134a							
Voltage	100V/50,60Hz	110V/60Hz	115, 120V/60Hz	127V/60Hz	220V/50Hz	220V/60Hz	230V/50Hz	240V/50Hz
Relay model	427THBZZ-52	308NHBYY-52	X	X	213THBYY-52	X	X	213THBYY-52
Part code	3018109620	3018114000	X	X	3018108100	X	X	3018108100

3. RUNNING CAPACITOR

Refrigerant	R12							
Voltage	100V/50,60Hz	110V/60Hz	115, 120V/60Hz	127V/60Hz	220V/50Hz	220V/60Hz	230V/50Hz	240V/50Hz
Spec.	X	X	X	X	X	350V/5μF	X	X
Part code	X	X	X	X	X	400EL15110	X	X

Refrigerant	R134a							
Voltage	100V/50,60Hz	110V/60Hz	115, 120V/60Hz	127V/60Hz	220V/50Hz	220V/60Hz	230V/50Hz	240V/50Hz
Spec.	250V/16μF	220V/12μF	X	X	X	X	X	X
Part code	3816801900	3816801910	X	X	X	X	X	X

4. F-FAN MOTOR

Refrigerant	R12, R134a							
Voltage	100V/50,60Hz	110V/60Hz	115, 120V/60Hz	127V/60Hz	220V/50Hz	220V/60Hz	230V/50Hz	240V/50Hz
Spec.	IS3211DREE	IS3211DREI	X	X	IS3211DREG	IS3211DREF	X	IS3211DREH
Part code	3015902400	3015903420	X	X	3015903400	3015902410	X	3015903410

5. DEFROST HEATER

Refrigerant	R12, R134a							
Voltage	100V/50,60Hz	110V/60Hz	115, 120V/60Hz	127V/60Hz	220V/50Hz	220V/60Hz	230V/50Hz	240V/50Hz
Spec.	100V/130W	←	X	X	220V/130W	←	X	220V/130W
Part code	3012802902	←	X	X	3012802912	←	X	3012802912

6. DEFROST TIMER

Refrigerant	R12, R134a							
Voltage	100V/50,60Hz	110V/60Hz	115, 120V/60Hz	127V/60Hz	220V/50Hz	220V/60Hz	230V/50Hz	240V/50Hz
Spec.	TMDEX09UA1	←	X	X	TMDEX09UM1	←	X	TNDEX09UM1
Part code	3018101200	←	X	X	3018100300	←	X	3018100300

7. DRYER

Refrigerant	R12	R134a
Spec.	5 g	10 g
Part code	4019L04000	3016801300

POWER CORD SPECIFICATION

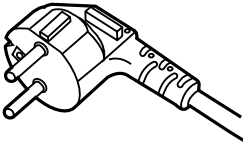
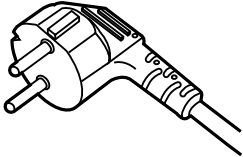
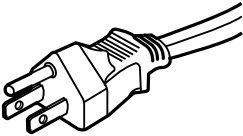
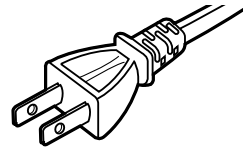
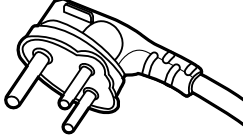
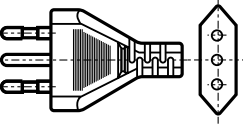
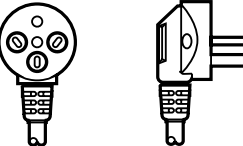
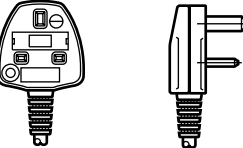
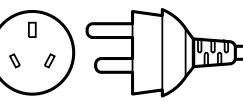
NO	SHAPE OF POWER CODE	PART CODE	DESCRIPTION	REMARK
1		3011315000	CP-2PIN	FOR EUROPEAN COUNTRY
2		401RA17200	CP-2PIN	FOR OTHER COUNTRY
3		4006D17101	KP-30	FOR AMERICA
4		401PD17101	KP-211	FOR JAPAN & TAIWAN
5		3011300801	BP-3PIN	
6		3011303010	#267	FOR CHILE
7		3011315310		FOR ISRAEL
8		3011303050	BS-1363A	FOR U.K, MIDDLE ASIA SINGAPORE & MALAYSIA
9		3011301200	KP-551/550	FOR CHINA & AUSTRALIA

* Upper power cord's part code is only for lead wire, without any kinds of terminal or housing.

9. DOOR COLOR SPECIFICATION

1. ASSEMBLY URETHAN DOOR

Refrigerant	R12				R134a			
Key type	Dull lamina sheet	High glossy lamina sheet	Normal PCM	High glossy bright PCM	Dull lamina sheet	High glossy lamina sheet	Normal PCM	High glossy bright PCM
Part code	X	X	PFDT1UC040	X	X	PFDT1UC220	PFDT1UC110	X

COLOR TABLE

1. PCM type

NO	COLOR CHIP	COLOR NAME
1		P/WITH (WH069)
2		'94 L/GRAY (GY158)
3		'95 L/GRAY (GY259)
4		'94 M/GRAY (GY331)
5		'95 M/GRAY (GY335)
6		'97 M/GRAY (GY267)
7		M. D/GRAY (GY750)
8		N/BLUE (BL718)
9		MINT GREEN (GN206)
10		'97 BEIGE (BE215)

2. Lamina sheet type

NO	COLOR CHIP	COLOR NAME
1		P/WITH (WH069)
2		'94 L/GRAY (GY158)
3		'95 L/GRAY (GY259)
4		'94 M/GRAY (GY331)
5		'95 M/GRAY (GY335)
6		'97 M/GRAY (GY267)
7		M. D/GRAY (GY750)
8		N/BLUE (BL718)
9		MINT GREEN (GN206)
10		S/GOLD
11		G/GREEN

10. EXPLODED VIEW AND PARTS LIST

1. Exploded view

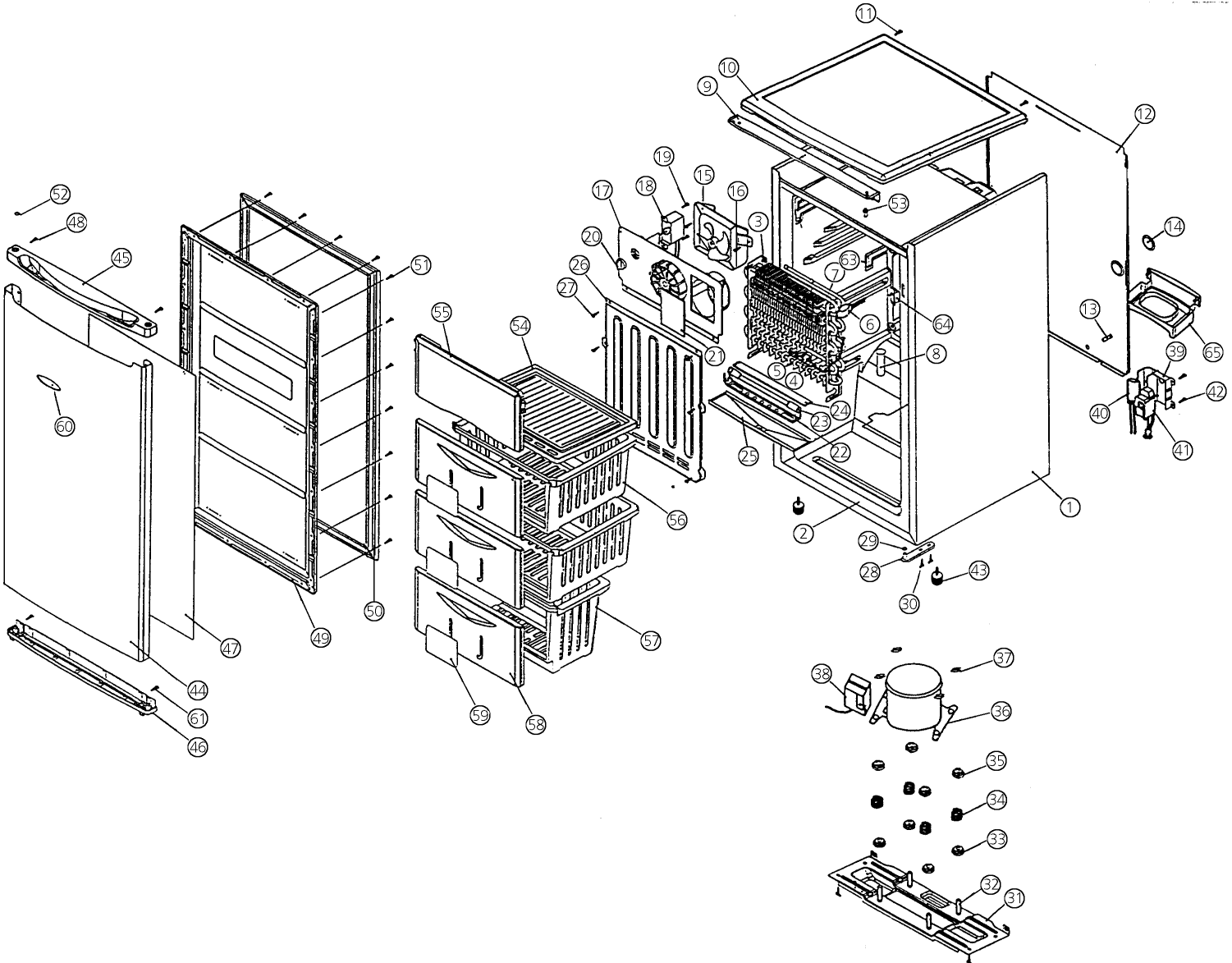

2. Parts list

NO	PART CODE	PART NAME	DESCRIPTION	QUANTITY	REMARK
1		CAB AS		1	
2	3017408900	LINER	ABS T2.7	1	
3	3017000300	EVAPORATOR SUS		1	
4	400EL21212	FUSE TEMP AS	70iC 10A	1	
5	4017Z90590	FIXTURE TEMP FUSE	PP	1	
6	3018100601	SWITCH BIMETAL AS		1	
7	7112401011	SCREW TAPPING	T1 TRS 4 X 12 MFZN	2	
8	3014412500	PIPE DRN		1	
9	3010609600	BRACKET T/P	CR T1.0	1	
10	3014203400	PANEL TABLE	PP	1	
11	7112400811	SCREW TAPPING	T1 TRS 4 X 8 MFZN	2	
12	3011422700	COVER CAB	PCM T0.4	1	
13	4018R30323	FIXTURE BOILD	PE-HD	2	
14	4009A32010	CAP URT HL BG	PE-HD	2	
15		MOTOR AS		1	REFER TO # 9
16	7112401611	SCREW TAPPING	T1 TRS 4 X 16 MFZN	2	
17	3018903100	LOUVER	HIPS	1	
18	3018300900	THERMOSTAT		1	
19	7112400811	SCREW TAPPING	T1 TRS 4 X 8 MFZN	2	
20	4017G31041	KNOB C/S	ABS	1	
21	3011422800	COVER LAMP	HIPS	1	
22	3011423200	COVER HTR *U	AL T0.4	1	
23		GLASS HTR TUBE AS		1	REFER TO # 9
24	3011423100	COVER HTR *T	AL T0.4	1	
25	3012503400	GUIDE DRN	AL T0.3	1	
26	3011422900	COVER EVA AS		1	
27	7112400811	SCREW TAPPING	T1 TRS 4 X 8MFZN	2	
28	3012902500	HINGE *U	SPHC-H T2.3	1	
29	4005G31170	WASHER *U HINGE		1	
30	7650602011	BOLT HEX	6B-1B 6 X 20HS MFZN	2	
31	3010305800	BASE COMP	SGCC T1.0	1	
32	4010G01123	SPECIAL BOLT	MSW-1 L47	4	
33	3010101420	ABSORBER COMP RUB B	NR	4	
34	3010101430	ASBORBER COMP SPG	SWP-B	4	
35	3010101400	ABSORBER COMP RUB A	NR	4	
36		COMPRESSOR		1	REFER TO # 8
37	4019H09030	SPECIAL WASHER	SWRM	4	
38		SWITCH P-RELAY AS		1	REFER TO # 8
39	3010511600	BOX POWER	PP	1	

NO	PART CODE	PART NAME	DESCRIPTION	QUANTITY	REMARK
40		CAPACITOR		1	REFER TO # 8
41		TIMER		1	REFER TO # 9
42	7112401211	SCREW TAPPING	T1 TRS 4 X 12 MFZN	2	
43	4017L32521	ADJ FOOT *L	PP	2	
44	3011710200	DOOR	PCM LAMINATE T0.5	1	
45	3010912200	CAP DR *T	ABS	1	
46	3010912300	CAP DR *U	ABS	1	
47	3011423300	COVER DR URT	KRAFT	1	
48	7112400811	SCREW TAPPING	T1 TRS 4 X 8 MFZN	2	
49	3017409000	LINER DR	ABS T1.0	1	
50	3012304300	GASKET	PVC-S	1	
51	7112400811	SCREW TAPPING	T1 TRS 4 X 8 MFZN	22	
52	3011424300	COVER DR CAP HL	PVC T0.25	1	
53	3014901600	SHAFT T/P BRK	SWRM-12C	1	
54	3017806600	SHELF Q/F	HIPS	1	
55	3011710300	DOOR Q/F	GPPS	1	
56	3011105700	CASE DRAWER A	PP	2	
57	3011105900	CASE DRAWAR B	PP	1	
58	3011423400	COVER DRAWER	HIPS	3	
59	3013524600	LABEL MANU	PVC	3	
60	3013524500	LABEL EBLM	URT FORM	1	
61	7112400811	SCREW TAPPING	T1 TRS 4 X 8 MFZN	2	
62	3012503300	GUIDE Q/F DR *L	PP	1	
63	3012503310	GUIDE Q/F DR *R	PP	1	
64	3018107700	SWITCH DR	PS-100	1	
65	3011108400	CASE VAPORI	PP	1	